

Geological Society of America Bulletin

The California River and its role in carving Grand Canyon

Brian Wernicke

Geological Society of America Bulletin published online 26 January 2011;
doi: 10.1130/B30274.1

Email alerting services

click www.gsapubs.org/cgi/alerts to receive free e-mail alerts when new articles cite this article

Subscribe

click www.gsapubs.org/subscriptions/ to subscribe to Geological Society of America Bulletin

Permission request

click <http://www.geosociety.org/pubs/copyrt.htm#gsa> to contact GSA

Copyright not claimed on content prepared wholly by U.S. government employees within scope of their employment. Individual scientists are hereby granted permission, without fees or further requests to GSA, to use a single figure, a single table, and/or a brief paragraph of text in subsequent works and to make unlimited copies of items in GSA's journals for noncommercial use in classrooms to further education and science. This file may not be posted to any Web site, but authors may post the abstracts only of their articles on their own or their organization's Web site providing the posting includes a reference to the article's full citation. GSA provides this and other forums for the presentation of diverse opinions and positions by scientists worldwide, regardless of their race, citizenship, gender, religion, or political viewpoint. Opinions presented in this publication do not reflect official positions of the Society.

Notes

Advance online articles have been peer reviewed and accepted for publication but have not yet appeared in the paper journal (edited, typeset versions may be posted when available prior to final publication). Advance online articles are citable and establish publication priority; they are indexed by PubMed from initial publication. Citations to Advance online articles must include the digital object identifier (DOIs) and date of initial publication.

The California River and its role in carving Grand Canyon

Brian Wernicke[†]

Division of Geological and Planetary Sciences, California Institute of Technology, Pasadena, California 91125, USA

ABSTRACT

Recently published thermochronological and paleoelevation studies in the Grand Canyon region, combined with sedimentary provenance data in both the coastal and interior portions of the North American Cordillera, place important new constraints on the paleohydrological evolution of the southwestern United States. Review and synthesis of these data lead to an interpretation where incision of a large canyon from a plain of low elevation and relief to a canyon of roughly the length and depth of modern Grand Canyon occurred primarily in Campanian time (80–70 Ma). Incision was accomplished by a main-stem, NE-flowing antecedent river with headwaters on the NE slope of the North American Cordillera in California, referred to herein after its source region as the California River. At this time, the river had cut to within a few hundred meters of its modern erosion level in western Grand Canyon, and to the level of Lower Mesozoic strata in eastern Grand Canyon. Subsequent collapse of the headwaters region into a continental borderland and coeval uplift of the Cordilleran foreland during the Laramide orogeny reversed the river's course by Paleogene time. After reversal, its terminus lay near its former source regions in what is now the Western Transverse Ranges and Salinian terrane. Its headwaters lay in the ancient Mojave/Mogollon Highlands region of Arizona and eastern California, apparently reaching as far northeast as the eastern Grand Canyon region. This system is herein referred to after its source region as the Arizona River. From Paleogene through late Miocene time, the interior of the Colorado Plateau was a closed basin separated from the Arizona River drainage by an asymmetrical divide in the Lees Ferry–Glen Canyon area, with a steep SW flank and gently sloping NE flank that drained into large interior lakes, fed primarily by Cordilleran/Rocky Mountain sources to the north and west, and by recycled California River detritus shed from Laramide uplifts on

the plateau. By Oligocene time, the lakes had largely dried up and were replaced by ergs. By mid-Miocene time, a pulse of unroofing had lowered the erosion level of eastern Grand Canyon to within a few hundred meters of its present level, and the Arizona River drainage below modern Grand Canyon was deranged by extensional tectonism, cutting off the supply of interior detritus to the coast. Increasing moisture in the Rocky Mountains in late Miocene time reinvigorated fluvial lacustrine aggradation NE of the asymmetrical divide, which was finally overtopped between 6 and 5 Ma, lowering base level in the interior of the plateau by 1500 m. This event reintegrated the former Arizona drainage system through a cascade of spillover events through Basin and Range valleys, for the first time connecting sediment sources in Colorado with the coast. This event, combined with the intensification of summer rainfall as the Gulf of California opened, increased the sediment yield through Grand Canyon by perhaps two orders of magnitude from its Miocene nadir, giving birth to the modern subcontinental-scale Colorado River drainage system. The Colorado River has thus played a major role in unroofing the interior of the Colorado Plateau, but was not an important factor in the excavation of Grand Canyon.

INTRODUCTION

How do landscapes evolve through significant amounts of geologic time? Because erosion disaggregates rock masses (as opposed to aggregating or modifying them), it presents a special challenge for study. Most of what is known about erosion concerns incremental changes in modern landscapes. Unconformities provide valuable records of the form of ancient erosion surfaces, but only provide a snapshot of the transition from erosion to aggradation. When regionally developed, they are generally cut on surfaces of very low relief. Kilometer-scale topographic forms characteristic of mountain belts, if preserved at all by unconformities, cover only a small fraction of eroding uplands. Studies of the eroded detritus in sedimentary

basins may contain evidence of the time, place, and even rate of erosion, but impose few constraints on the evolution of topographic form.

A promising avenue of research in this otherwise discouraging endeavor stems from the fact that isothermal surfaces in the uppermost crust more-or-less assume the geometry of ancient topography, leaving behind a sort of palimpsest of the ancient landscape, especially in the case of wide, deep canyons. After a period of kilometer-scale erosion, the most direct expression of the ancient topographic form is its thermal imprint. By using thermal structure to reconstruct ancient relief and comparing it to modern relief in the same mountainous region, fundamental questions about landscape evolution may be addressed. For example, does relief generally decrease as a function of time in a “geographical cycle” of youth, maturity, and old age (Davis, 1899), or does topographic form quickly attain a “dynamic equilibrium” that changes little as erosion proceeds (Hack, 1960)? Although both end members have been extensively discussed and applied to the time and length scales of late Quaternary erosion (e.g., Heimsath et al., 1999), we are only just beginning to address whether extrapolation of these results applies to kilometer-scale erosion acting over time scales of 10–100 m.y. (e.g., Reiners and Shuster, 2009).

Relief on isothermal surfaces created by topography decreases exponentially downward (e.g., Section 4–12 in Turcotte and Schubert, 1982), so thermochronometric measurements at depths within 1–2 times the amplitude of topography, or within the upper ~4 km of the crust for most mountain belts, provide the best opportunity for reconstructing landscapes. Given that temperatures at these depths are generally below 100 °C, the most effective thermochronometers for detecting this signal are fission-track and (U-Th)/He dating of apatite (e.g., Stüwe et al., 1994; House et al., 1998, 2001).

Debate over the origin of Grand Canyon, the planet's most vivid illustration of kilometer-scale erosion, has been invigorated over the last two years by application of these and other proxies for erosion and paleoelevation in the region (e.g., Flowers et al., 2008; Hill et al., 2008; Hill and Ranney, 2008; Karlstrom et al.,

[†]E-mail: brian@gps.caltech.edu

2008; Pearthree et al., 2008; Pederson et al., 2008; Polyak et al., 2008a, 2008b; Young, 2008). Grand Canyon is a long, relatively wide canyon through which surface waters of a large area of the southwestern U.S. interior pass before ultimately reaching the Gulf of California. The high plateaus surrounding Grand Canyon constitute the most imposing of a series of kilometer-scale topographic obstacles (e.g., the Kaibab arch, Fig. 1) that the Colorado River and its primary northern tributary, the Green River, cut improbably across as “transverse drainages” (e.g., Douglass et al., 2009), which in-

spired the classical concepts of antecedent and superposed drainage (Powell, 1875). In antecedence, the erosive power of a stream formed in a region of low relief is sufficient to maintain its grade during tectonic distortion of the landscape, whereas in superposition, the stream originates in flat-lying post-tectonic strata, and cuts downward across structure. The first few decades of exploration of these canyons thus led to a general debate about whether these rivers were older than the Laramide structures they cut through and therefore antecedent (e.g., Powell, 1875; Dutton, 1882; Walcott, 1890), or

younger, developed on post-tectonic fill (e.g., Emmons, 1897).

Over more recent decades, a contrary consensus has emerged, holding that incision of Grand Canyon began in late Miocene time, when two previously separate drainage basins became integrated (e.g., Longwell, 1946; McKee et al., 1967; Lucchitta, 1972, 2003). There is general consensus that integration occurred between 6 and 5 Ma, before which an older upper basin and a younger lower basin were separated by a drainage divide somewhere in the vicinity of the Kaibab arch (e.g., Hill et al., 2008; Karlstrom

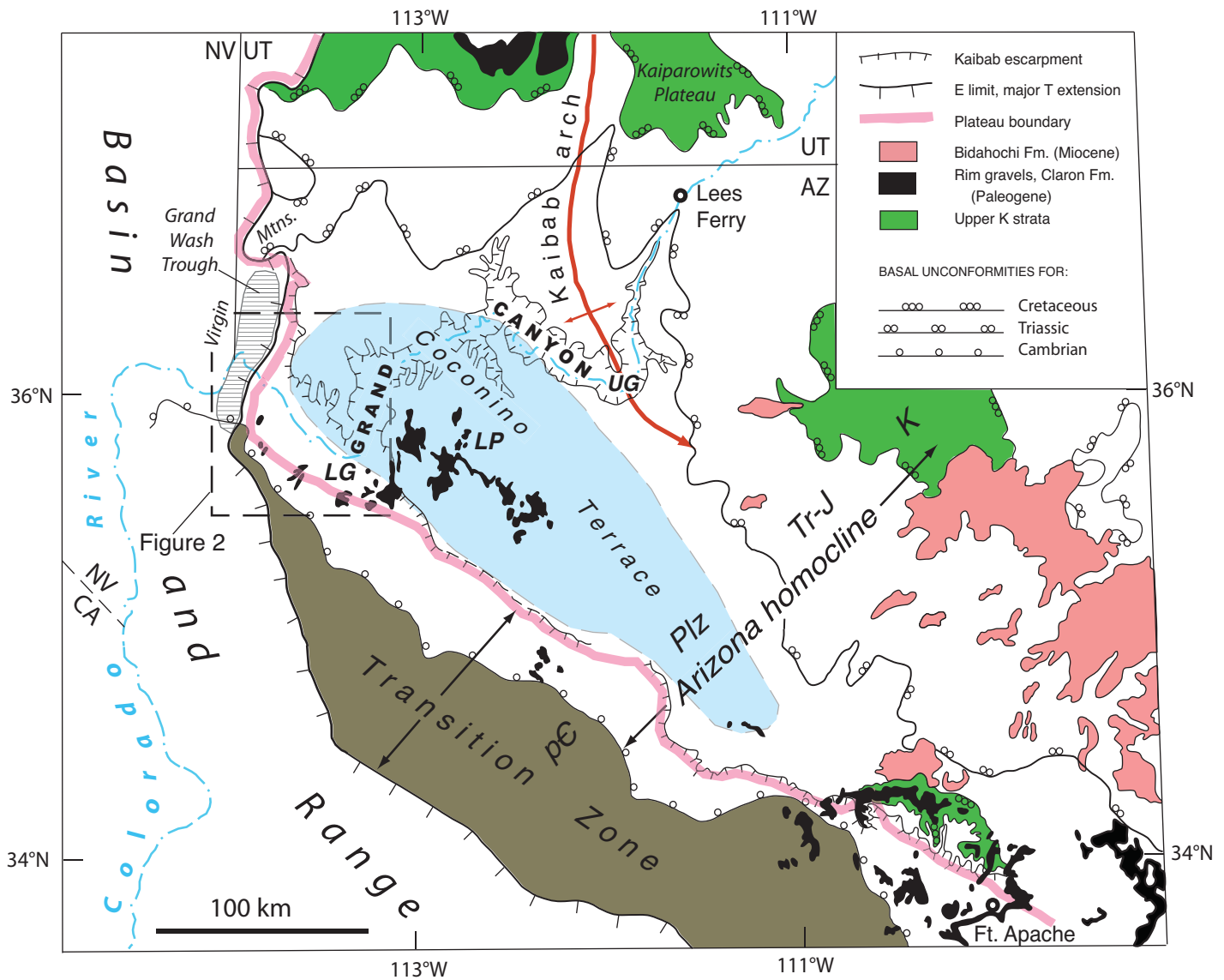

Figure 1. Tectonic map showing selected geographical and geological features discussed in text. Geology of Colorado Plateau and Transition Zone is generalized with late Cenozoic volcanic units removed. Boundary of Coconino terrace (light-blue area), based on regional elevation of the top of the Kaibab Formation at 1600 ± 200 m, is based on contour map of Hunt (1969). LG—Lower Granite Gorge of Grand Canyon; LP—Long Point area; UG—Upper Granite Gorge; pC—Proterozoic crystalline and overlying Proterozoic stratified rocks; Plz—Paleozoic strata; Tr-J—Triassic and Jurassic strata; K—Cretaceous strata.

et al., 2008; Pearthree et al., 2008; Pederson et al., 2008). Integration would thus require either piracy of the upper basin by the lower, or lateral spillover from the upper basin into the lower, or perhaps some combination of the two (e.g., Hunt, 1969; Spencer and Pearthree, 2001; Pederson, 2008). Following in the footsteps of a long history of debate about the evolution of pre-Grand Canyon drainages (reviewed in Powell, 2005), various and contrasting proposals have recently been made for at least some pre-6 Ma incision of significant portions of Grand Canyon (e.g., Polyak et al., 2008a; Hill and Ranney, 2008), both upstream and downstream of the Kaibab arch, with varying amounts of incision dating perhaps as far back as Laramide time (Late Cretaceous through Eocene; e.g., Flowers et al., 2008; Young, 2008). Even these studies, however, did not view pre-6 Ma incision to have been accomplished by an antecedent river crossing the arch, nor did they challenge the piracy/spillover paradigm.

In this paper, I review the geologic setting and contemporary thinking about the origin of Grand Canyon, which revolves around an issue informally known among analysts as “the Muddy Creek problem.” I then review critical evidence bearing on (1) the thermal history of the shallow crust in the region, (2) the Cenozoic elevation and climatic history of the southern portion of the Colorado Plateau, and (3) the relationship between the timing and geometry of Grand Canyon erosion and the provenance of depocenters (a) within the Grand Canyon region (Rim gravels and other deposits), (b) upstream of Grand Canyon in Utah, and (c) downstream of Grand Canyon in southern California. These constraints are synthesized into a new first-order paleohydrological reconstruction of the region that now includes the southern portion of the Colorado River drainage basin from Campanian to Quaternary time, reconciling it with the Muddy Creek problem and new constraints on the late Quaternary incision rate of Grand Canyon.

Geologic Setting

Grand Canyon is a sinuous, 300-km-long, 15–20-km-wide, and ~1500-m-deep gorge through the southwestern Colorado Plateau (Fig. 1). Although not the deepest, because of its extraordinary length, it is volumetrically among the largest river gorges on Earth. It is cut mainly within a structural terrace (flat-lying strata between two monoclines) that interrupts an otherwise gently NE-dipping (0.4°) homocline of cratonic Paleozoic through Tertiary strata that forms the SW quadrant of the plateau (Fig. 1). The homocline measures ~500 km along strike

and 200 km across, with the structural terrace occupying a 200-km-long, 50–100-km-wide area within its NW portion (Hunt, 1969). The structural terrace lies at a mean elevation of 1900 m, and its erosion surface is almost exclusively cut near the contact between the Permian Kaibab and Triassic Moenkopi Formations, or on unconformably overlying Tertiary basalts. The principal structural features disrupting this pattern are relatively modest net offsets along the N-trending Hurricane and Toroweap faults in the western part of the canyon, and the Kaibab arch along the eastern part (e.g., Karlstrom et al., 2008), both of which are associated with innumerable smaller monoclinical flexures and faults (e.g., Billingsley et al., 1996). Within the Kaibab arch, the canyon rim gradually rises eastward an additional 400 m before descending abruptly at the canyon’s eastern terminus. Because of the importance of the homocline and structural terrace to the discussion, I will refer to them informally herein as the “Arizona homocline” and “Coconino terrace,” with the understanding that the former includes parts of southern Utah and the latter is more extensive than the physiographic Coconino Plateau (Fig. 1).

In Grand Canyon, the Colorado River cuts downward through the Paleozoic section and into basement rocks between Lees Ferry and the Upper Granite Gorge, and then runs at a level near the basal Cambrian unconformity. It descends at a nearly constant gradient of ~1.3 m/km through the canyon, from an elevation of 940 m at Lees Ferry near its eastern end, to 360 m at its western end where it enters Grand Wash Trough (Fig. 1). There, the river crosses the abrupt transition between the Colorado Plateau and Basin and Range physiographic provinces, and enters the topographically lower surroundings of Grand Wash Trough (Fig. 2). The westernmost segment of the canyon trends NW along the SW margin of the Coconino terrace (Fig. 1). Immediately SW of this river segment, the Paleozoic section acquires a gentle NE dip and forms the Hualapai Plateau (Fig. 2).

Grand Wash Trough is bounded on its east side by a rampart of flat-lying Paleozoic strata known as the Grand Wash Cliffs, and on its west side by the Virgin Mountains (Fig. 2). Near the center of the trough, a low, narrow ridge named Wheeler Ridge consists of steeply E-tilted Paleozoic bedrock unconformably overlain by variably E-tilted Tertiary strata, ranging from 24 to 18 Ma deposits of the Rainbow Gardens Member of the Horse Spring Formation (Bohannon, 1984; Beard, 1993) to gently tilted 4.4 Ma Colorado River gravels (Fig. 3; Howard and Bohannon, 2001; Howard et al., 2008). Wheeler Ridge is the easternmost of a series of domino-like

normal fault blocks and associated basement-cored uplifts that were tilted during a middle Miocene pulse of extensional deformation (Wernicke and Axen, 1988; Brady et al., 2000; Billingsley et al., 2004; Wallace et al., 2005; Quigley et al., 2010).

In Grand Wash Trough and other basins to the west, the tilted fault blocks are primarily overlain by >500 m of gently tilted to flat-lying Miocene basin fill, deposited between 13 and 6 Ma, generally referred to as the Muddy Creek Formation (Fig. 3; Longwell, 1936; Lucchitta, 1979; Wenrich et al., 1996; Karlstrom et al., 2008) or the informal designations “rocks of the Grand Wash Trough” (Bohannon, 1984; Wallace et al., 2005) and “sedimentary rocks of the Grand Wash Trough” (Billingsley et al., 2004). Within the trough, the modern Colorado River drainage system dissects a 6 Ma fill surface and underlying rocks to a depth of ~500 m, exposing the three-dimensional geometry of the Muddy Creek depositional basin and its pre-Tertiary substrate (Fig. 3). Near the modern level of Lake Mead at Sandy Point (Fig. 2), thin deposits of well-rounded fluvial gravel of similar composition to the modern Colorado River bed load unconformably overlie the Muddy Creek Formation and are intercalated with a basalt flow dated at 4.4 Ma (Howard and Bohannon, 2001).

Upper Mesozoic and Paleogene strata along the NE flank of the Arizona homocline crop out mostly in southern Utah and northeasternmost Arizona (Fig. 1). The SW portion of the Arizona homocline lies within the Arizona Transition Zone, a NW-trending, 500 km × 100 km region that includes mainly Proterozoic basement exposures, exhibiting a structural and physiographic gradation between the little-faulted Colorado Plateau at 1900 m elevation and the highly extended southern Basin and Range Province, generally at <500 m elevation (Fig. 1; e.g., Elston and Young, 1991; Foster et al., 1993; Potochnik, 2001). Throughout the Transition Zone and much of the Basin and Range, Tertiary strata lie nonconformably on basement rocks. Astride the boundary between the Colorado Plateau and the Transition Zone, Paleogene deposits, known informally as the “Rim gravels” (Fig. 1), indicate NE paleoflow (Elston and Young, 1991; Potochnik, 2001). Mid-Tertiary and younger gravels in the Transition Zone indicate NE to SW flow similar to the modern regime, indicating that a reversal in the drainage pattern occurred in mid-Tertiary time (e.g., Peirce, 1979; Holm, 2001). Prior to the reversal, erosional unroofing of the Transition Zone and areas to the SW is regarded by most workers as focused on the ancient “Mogollon Highlands” of central Arizona or “Kingman arch” of northwestern Arizona, flanked by a drainage

Figure 2. Shaded relief map of western Grand Canyon–Lower Granite Gorge region showing locations of sections and map in Figures 3, 8, and 12, the location of paleocanyons (generalized from Young, 2008), sample locations of the three (U-Th)/He apatite ages shown in Figure 5 and discussed in text (magenta circles; after Flowers et al., 2008), and selected geographical features discussed in text.

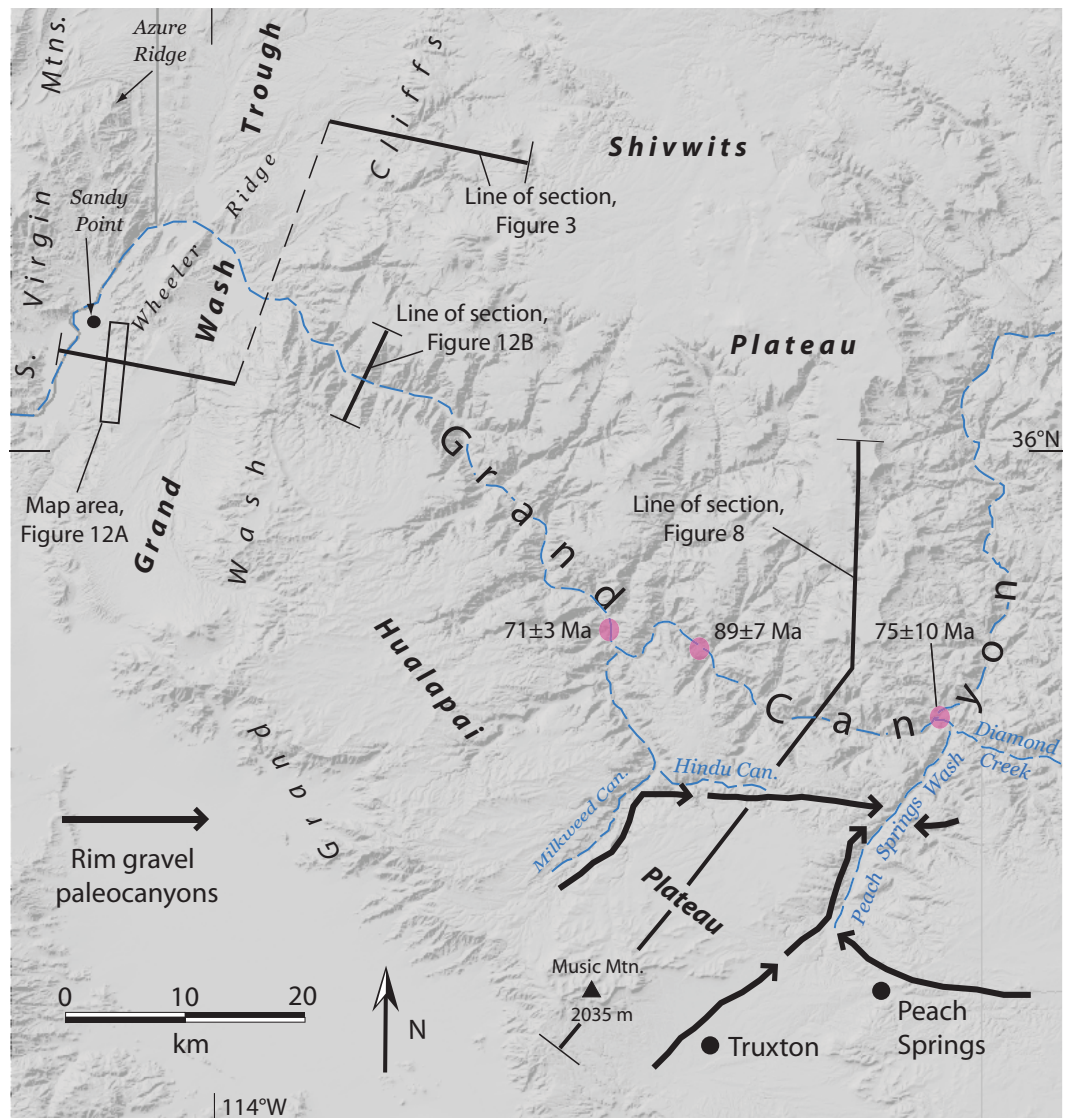

network that carried detritus NE onto lowlands that now form the Colorado Plateau (e.g., Elston and Young, 1991; Potochnik and Faulds, 1998; Potochnik, 2001; Dickinson and Gehrels, 2008).

The rise of the Mogollon Highlands was protracted, as suggested by two regional unconformities within the Arizona homocline, one overlain by Cretaceous strata and the other by the Paleogene Rim gravels, both of which progressively cut downsection toward the SW. The sub-Cretaceous unconformity cuts from a substrate of Upper Jurassic strata in northeastern Arizona down to Permian strata along the SW edge of the plateau in the Fort Apache region of the Transition Zone (Fig. 1; e.g., Finnell, 1966; Hunt, 1969). The sub-Rim gravel unconformity cuts abruptly downward from Permian-Triassic strata on the SW margin of the plateau to Proterozoic basement in the Transition Zone, in both the

Grand Canyon and Fort Apache regions (e.g., Young, 2001a). According to a reconstruction of a regional cross section through these widely exposed unconformities by Flowers et al. (2008; see also Potochnik, 2001), of a total 5500 m of structural relief on the basal Cambrian unconformity, ~2300 m had developed by ca. 94 Ma (late Cenomanian), and an additional 3200 m developed between ca. 80 and 50 Ma. These data indicate that a significant fraction of the structural relief across the Arizona homocline is pre-Laramide (e.g., Potochnik, 2001). Whereas the older unconformity is cut on a surface of perhaps a few tens of meters of local relief, the sub-Rim gravel unconformity preserves local relief of at least 1200 m on the Hualapai Plateau, just south of the westernmost segment of Grand Canyon (e.g., Young, 1979), and at least 850 m in the Fort Apache region (Potochnik, 2001).

The Muddy Creek Problem

Debate over the origin of Grand Canyon in particular, and therefore the paleohydrology and paleotopography of the southwestern United States in general, has intensified over the last three years, owing to the publication of a wealth of new or greatly refined geochronological and thermometric measurements bearing on the canyon's history. These include (1) U/Pb dating of speleothems in and near the canyon walls (Polyak et al., 2008b); (2) high-precision $^{40}\text{Ar}/^{39}\text{Ar}$ dating of basalts intercalated with river-terrace deposits (Karlstrom et al., 2007; Crow et al., 2008); (3) (U-Th)/He dating of igneous and detrital apatites across the region (Flowers et al., 2008); (4) U/Pb dating of large populations of detrital zircons in sedimentary basins related to regional erosion (Larsen,

California River

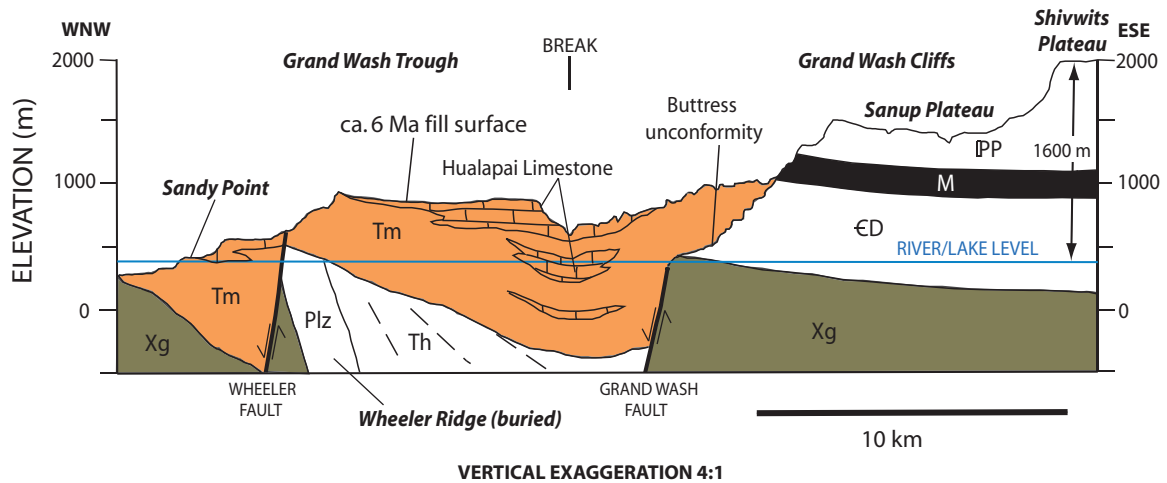

Figure 3. Cross section showing stratigraphic and structural relations at the western terminus of Grand Canyon. Section to the left of the break is modified after Wallace et al. (2005), and section to the right of the break is modified after Billingsley et al. (2004). Xg—Proterozoic basement; €D—Cambrian through Devonian strata; M—Mississippian strata; PP—Pennsylvanian and Permian strata; Plz—Paleozoic strata undifferentiated; Th—Horse Spring Formation; Tm—Muddy Creek Formation (sedimentary rocks of Grand Wash Trough). See Figure 2 for location of section.

2007; Link et al., 2007; Dickinson and Gehrels, 2008, 2009; Jacobson et al., 2010; Jinnah et al., 2009; Davis et al., 2010; Larsen et al., 2010); and (5) paleoaltimetry of the plateau using “clumped isotope” thermometry of lacustrine carbonates (Huntington et al., 2010). The torrent of fresh information has renewed community interest in what has long been the central issue in explaining the history of the canyon, namely the “Muddy Creek problem” (Blackwelder, 1934; Longwell, 1936, 1946; Lucchitta, 1972; Faulds et al., 2001; Pederson, 2008).

As concluded by Karlstrom et al. (2008, p. 835),

After over a century of controversy there is a growing consensus that Grand Canyon has formed in the past 6 Ma (Young and Spamer, 2001). In this consensus, the term Grand Canyon is used for the canyon system carved by a west-flowing Colorado River, not for local precursor canyons (Young, 2008), or for northeast-flowing Tertiary drainages that may have existed in now-eroded Mesozoic strata (Flowers et al., 2008).

The cornerstone of this consensus is that any hypothesis favoring the existence of a pre-6 Ma Colorado River cannot account for the fact that the Muddy Creek Formation in Grand Wash Trough, which includes coeval deposits assigned to the Hualapai Limestone (Fig. 3), contains exclusively locally derived detritus in lacustrine and alluvial-fan depositional facies, contrasting strongly with the rounded detritus of exotic provenance characteristic of the bed load in the modern river channel. Despite continuous exposures and

a 7 m.y. depositional span from 13 to 6 Ma across the western terminus of Grand Canyon, the Muddy Creek near the mouth of Grand Canyon does not exhibit sedimentary structures indicative of fluvial deposition or a large river system emanating from Grand Canyon (Longwell, 1946; Lucchitta, 1966, 1979; Hunt, 1969; Faulds et al., 2001; Wallace et al., 2005). The core of the Muddy Creek problem is, thus, reconciling the relatively slow accumulation of a small volume of locally derived sediment in a Miocene half-graben with a hypothetical pre-6 Ma Colorado River that would have flowed through it during this time. As summarized by Karlstrom et al. (2008, p. 835),

Evidence for *inception of carving* of the Grand Canyon after 6 Ma is strong. (1) The sedimentary record shows that there are no Colorado River sediments in the 13–6 Ma Muddy Creek Formation that now blankets the Grand Wash Trough at the mouth of Grand Canyon (Lucchitta, 1972; Faulds et al., 2001). (2) The first sediments containing distinctive sand composition and detrital zircons that can be traced to Rocky Mountain sources reached the newly opened Gulf of California at 5.3 Ma (Dorsey et al., 2007; Kimbrough et al., 2007). (3) Gravels on top of the 6 Ma Hualapai Limestone and beneath the 4.4 Ma Sandy Point basalt show that the river became established in its present course between 6 and 4.4 Ma. (*italics added*)

At issue is whether these facts preclude significant—or nearly complete—carving of Grand Canyon prior to 6 Ma. The observations behind the consensus relate to drainage *integration*, and do not contain direct information about when *incision* of Grand Canyon occurred (e.g.,

Polyak et al., 2008b; Hill and Ranney, 2008; Young, 2008). As noted already, young incision necessitates connection of the upper and lower parts of the basin through piracy or spillover (McKee et al., 1967). Although the element of connecting the two drainages across the Kaibab arch and Coconino terrace sensibly resolves the Muddy Creek problem, it also leads to a cascade of puzzling consequences that have fueled controversy over the past 70 years.

Leaving Grand Canyon substantially uncarved at 6 Ma requires no ordinary integration, but integration of a highly organized, focused extant upper drainage through the edifice of the westernmost plateau (McKee et al., 1967; Lucchitta, 2003). The ensuing problems include: (1) the location of the abandoned downstream reach of the upper basin prior to integration (suggested courses have included the Rio Grande according to McKee et al. [1967]; western Arizona according to Hunt [1969]; southern Utah via the southern Kaibab arch, according to Lucchitta [1984]); (2) the reason why a well-integrated, subcontinental-scale drainage would have changed its course in the middle of a tectonically stable block; and (3) the requirements of (a) headward erosion from the Grand Wash Cliffs, (b) spillover of some form of upstream dam >150 km east of the Grand Wash Cliffs at 6 Ma, or (c) both.

Headward erosion from the Grand Wash Cliffs raises the question of (4) why one of a series of small, arid canyons without perennial streams, similar to adjacent canyons now cut into

the cliffs, would spontaneously develop into one of the great erosional spectacles of the planet (e.g., Spencer and Pearthree, 2001). In the gentle sarcasm of Hunt's (1968) book review of McKee et al. (1967), it would have been a "precocious gully" indeed. In regard to an upstream dam, evidence for some form of pre-6 Ma ponding immediately upstream of Grand Canyon is good—the fluvio-lacustrine Bidahochi Formation blanketed a large area of northeastern Arizona between 16 and 6 Ma, and slow, episodic aggradation appears to have given way to rapid erosion at ca. 6 Ma, perhaps as a result of the integration recorded downstream (e.g., Scarborough, 2001; Meek and Douglass, 2001; Douglass et al., 2009). The existence of other, now-eroded Miocene ponding sites in the Glen Canyon area is certainly possible (Hunt, 1969; Hill and Ranney, 2008). However, as long noted by many (e.g., McKee et al., 1967; Hunt, 1969; Hill et al., 2008), (5) the rim of Grand Canyon at the point where spillover would have occurred along the crest of the Kaibab arch, at roughly 2250 m elevation, lies ~300 m above the Bidahochi Formation, and towers 1300 m above the current elevation of the river where it enters Grand Canyon south of Lees Ferry (Fig. 1). Any such lake, even if it were as deep and areally extensive as would be needed, seems more likely to have drained into much lower ground that exists to the north and south of the modern canyon in avoidance of the structurally high crest of the Kaibab arch (e.g., Spencer et al., 2008a; Douglass et al., 2009).

The enigmatic consequences of piracy or spillover across the Kaibab arch have led to necessarily elaborate hypotheses involving cutting of most of eastern Grand Canyon during the Laramide to mitigate the height issue of the spillover point (Scarborough, 2001), or integration via a period of subterranean underflow through the regional Cambrian-Mississippian carbonate aquifer, at first feeding the Hualapai Limestone at the foot of the Grand Wash Cliffs, and ultimately developing karstic collapse along the modern course of the river (e.g., Hunt, 1969; Pederson, 2008; Hill et al., 2008).

THERMAL HISTORY OF THE SHALLOW CRUST IN THE GRAND CANYON REGION

Methods

At cooling rates typical of erosional unroofing, common primary igneous and detrital apatites completely anneal fission tracks above 110 °C (e.g., Laslett et al., 1987). Samples that cool quickly from temperatures above 110 °C to near-surface temperatures preserve popula-

tions of fission tracks that cluster at ~14.0–14.5 μm long (e.g., Fitzgerald et al., 1991). For apatite grains that reside below 110 °C for long periods of time, partial annealing of the tracks occurs, which may result in a younger age than the time at which the samples cooled through 110 °C. Depending on the thermal history, populations of track lengths exhibit means that are typically 10%–20% shorter than those of rapidly cooled samples and exhibit a greater variance about the mean (e.g., Kelley et al., 2001). Although 60 °C has been regarded as a nominal lower limit for significant annealing, track length reductions of up to 11% have been observed in natural apatites residing well below 60 °C over geologic time scales (e.g., Spiegel et al., 2007).

For (U-Th)/He analysis, at geologic time scales, apatites that have not been damaged by radioactivity do not retain helium above 70 °C, and retain most or all of it below 30 °C (e.g., Farley, 2000). Partial retention occurs between 30 °C and 70 °C. For samples with significant residence time below 110 °C, age may correlate strongly with the effective U concentration (eU) in the sample. Higher eU samples are much more retentive of He than lower eU samples, because radiation damage creates traps that are retentive of He (Shuster et al., 2006; Flowers et al., 2007). For igneous apatites, variation in eU within samples may be quite limited. Nonetheless, samples from neighboring plutons may exhibit a wide variation in eU and age. For detrital apatites, a single sample may yield a population with wide variation in eU and age. In both plutonic and detrital samples, the variation of age as a function of eU in some instances can be modeled to constrain the thermal history of the area (Flowers et al., 2007, 2008).

Existing apatite fission-track and He data for Grand Canyon and environs include fission-track analyses of both igneous samples from the basement and detrital samples from Proterozoic and Phanerozoic strata. Extant data are sufficient to infer cooling histories of samples within eastern and western Grand Canyon (Upper Granite Gorge and Lower Granite Gorge areas, respectively, Fig. 1), as well as in tilted fault blocks in the Virgin Mountains (Azure Ridge area, Fig. 2) that had a full Paleozoic section on top of them until ca. 17 Ma (Fig. 4). Although now within the Basin and Range tectonic province, prior to ca. 17 Ma, the Virgin Mountains resided in the cratonic foreland of the retroarc Cordilleran fold-and-thrust belt (Sevier orogen; e.g., DeCelles, 2004), in stratigraphic and structural continuity with the modern Grand Wash Cliffs. Therefore, its thermal history is a reasonable proxy for that of the adjacent plateau prior to extensional

tectonism (e.g., Fitzgerald et al., 1991, 2009; Reiners et al., 2000). This connection is critical because it allows comparison of the pre-17 Ma cooling history of the canyon with that of the surrounding plateaus. In the next section, following convention, "apatite fission-track" will be abbreviated as AFT, "apatite helium" as AHe, "partial-annealing zone" as PAZ, and "partial-retention zone" as PRZ.

Cooling Histories of Samples in the Eastern Grand Canyon Region

Apatite Fission-Track Ages

AFT ages from basement rocks in the eastern, deepest segment of the canyon near the crest of the Kaibab arch are 63 ± 2 Ma, with track lengths of ~12.0–12.6 μm, indicating significant residence in the PAZ after 65 Ma (Dumitru et al., 1994). The data of Naeser et al. (1989) and Kelley et al. (2001), which cover a broader area of the Upper Granite Gorge, show a scattering of ages between 70 and 30 Ma, with mean track lengths as low as 10.7 μm. The short track lengths require significant residence time in the PAZ, and as such, the measured ages generally underestimate the age at which the samples passed through 110 °C. Assuming a proportionate scaling between age reduction and track-length reduction of 1:1 for the oldest, least annealed samples (Green, 1988), Dumitru et al. (1994) estimated an age of cooling through 110 °C of 75 ± 6 Ma for samples at the bottom of the Upper Granite Gorge in the vicinity of the Kaibab arch (point B, Fig. 4A).

Forward modeling of age and track-length distributions using a Monte Carlo approach (e.g., Ketcham et al., 1999) suggests two pulses of cooling in this area, the first through 110 °C between 80 and 70 Ma, residence at temperatures of 60 ± 10 °C through most of Tertiary time, followed by final cooling to surface temperatures in the late Tertiary (curve B, Fig. 4C; Kelley et al., 2001).

The modeling by Kelley et al. (2001) also suggests differences in both ages and cooling histories across a small fault in the Upper Granite Gorge (~100 m net offset), with temperatures ~10 °C warmer on one side of fault than on the other through most of Tertiary time, in turn suggesting 200–300 m of offset of isothermal surfaces. Alternatively, because similar age variations also occur over distances of as little as 10 km where no structures exist, they may simply be a function of contrasting annealing kinetics in different rock types, which in any event are poorly understood for samples near the top of the PAZ (~60 °C). For example, the South Virgin Mountains contain one of the most extensively studied fossil PAZs in the world.

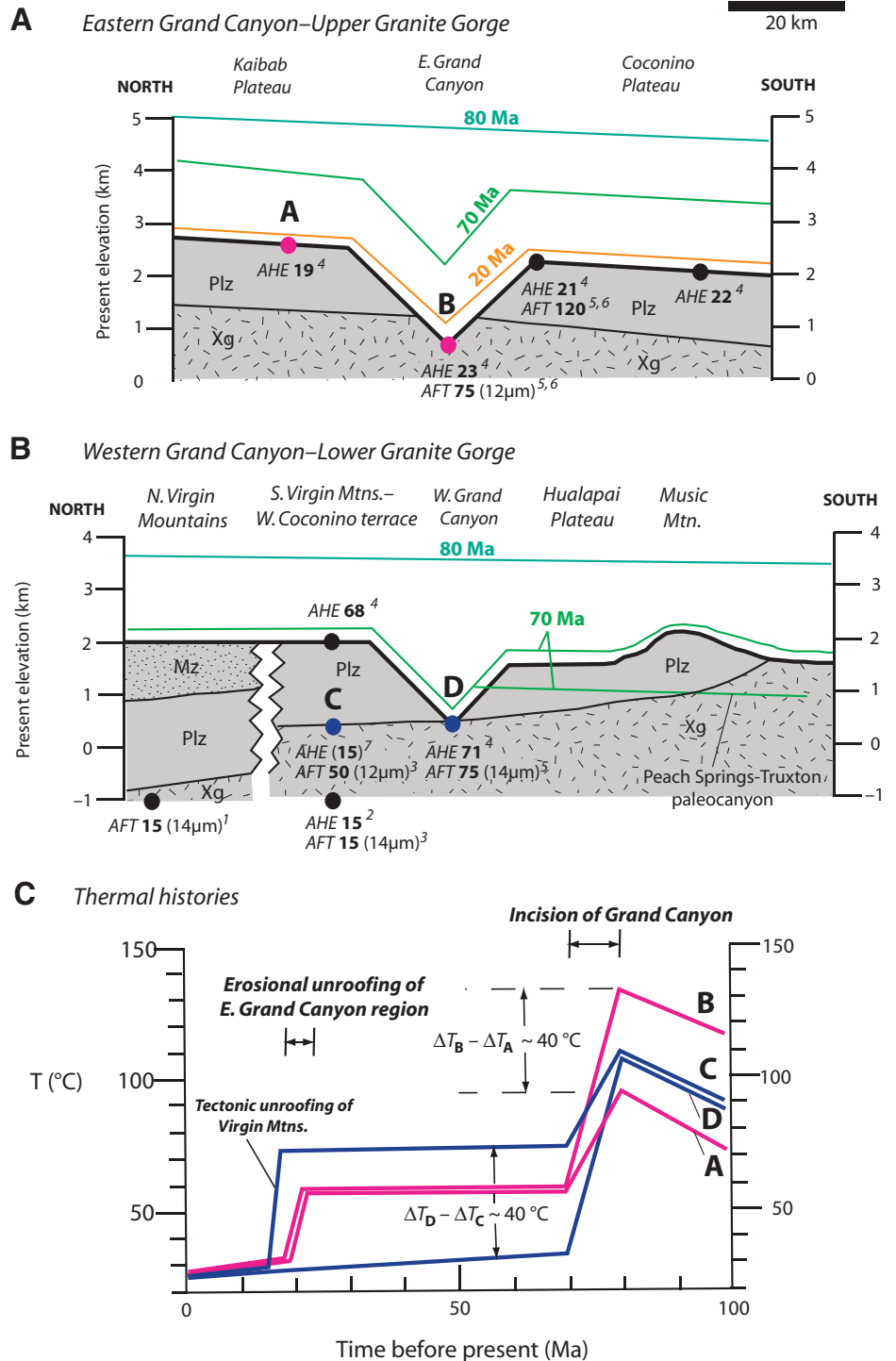

Figure 4. Schematic cross sections showing representative thermochronological data, low-temperature thermal histories, and erosion histories for Grand Canyon region. Erosion histories assume a geothermal gradient of 25 °C/km. (A) Section showing positions of rim and gorge samples (circles) and inferred position of the erosion surface (colored lines) at the times indicated on the curves in the eastern Grand Canyon region. AHE—(U-Th)/He apatite age; AFT—fission-track apatite age, showing mean track lengths in parentheses. Here, representative ages shown are not averages of measured ages, but calculated times of rapid cooling through most or all of the AFT partial annealing zone or AHE partial retention zone, as discussed in text. (B) As in A for western Grand Canyon; ages for point D are from the Diamond Creek area, where both AHE and AFT data exist. Sources of data: 1—Quigley et al. (2010); 2—Reiners et al. (2000); 3—Fitzgerald et al. (1991, 2009); 4—Flowers et al. (2008); 5—Kelley et al. (2001); 6—Dumitru et al. (1994); 7—age inferred from structural position between the surface and the base of the partial annealing zone for apatite fission tracks (Fitzgerald et al., 1991; Reiners et al., 2000). (C) Cooling histories for the four lettered sample positions in A and B, and discussed in text.

There, the ages of samples near the top of the PAZ exhibit ~30 m.y. of variation at any given depth, similar to the pattern in the Upper Granite Gorge (fig. 5 in Fitzgerald et al., 2009). Hence, although some of the variation in AFT age may be the result of minor faulting, overall the structural relief on the basal Cambrian unconformity in the inner gorge is a small fraction of

the topographic relief, and apparent variations in Tertiary residence temperatures represent at most only 25% of the total amount of cooling that occurred from 80 to 70 Ma. AFT ages in samples above the basement generally increase rapidly upward within the Phanerozoic section, suggesting that the base of the PAZ (110° isotherm) at 80 Ma was near

(Dumitru et al., 1994) or below (Kelley et al., 2001) the basement samples. From 60 to 20 Ma, the base of the PAZ at 110 °C would have had to have been at least 1500 m deeper in order to maintain the samples near 60 °C, assuming a maximum geothermal gradient of 30 °C/km. This provides a minimum estimate of the amount of Late Cretaceous (Campanian–Maastrichtian) erosion of

eastern Grand Canyon of ~1500 m, similar to the minimum estimate of 1200 m suggested by Dumitru et al. (1994; Figs. 4A and 4C).

Apatite (U-Th)/He Ages

AHE ages on low-eU basement samples in the gorge are generally younger than the AFT ages, consistent with residence near 60 °C for much of Tertiary time, as suggested by the AFT modeling. The gorge samples yield a strong correlation between eU and age. Using a radiation-damage model of the age-eU dependence, the samples resided near 55 °C between 65 and 20 Ma, at which time they cooled rapidly from >50 °C to <32 °C (Flowers et al., 2008). The AHE data thus independently confirm the two-stage cooling history suggested by the AFT data, and refine the timing of cooling to near-surface temperatures to be ca. 20 Ma (point B, Fig. 4A).

In marked contrast to the AFT data, AHE data from samples on the canyon rim near the crest of the Kaibab arch north of Grand Canyon yield the same ages and age-eU curves as the basement samples in the gorge, which are 1500 m lower in elevation (point A, Fig. 4A). These data also suggest residence near 55 °C from 65 to 20 Ma, followed by rapid cooling to near-surface temperatures at 20 Ma (Flowers et al., 2007, 2008). South of the canyon, apatites from four samples on the plateau did not yield systematic age-eU variations for thermal modeling, but as for samples within and north of the canyon, the youngest ages in these samples are consistently quite young and range from 28 to 18 Ma, indicating that they had reached near-surface temperatures during that interval (Fig. 4A; Flowers et al., 2008).

Even though the AHE data indicate that the sub-65 °C cooling histories of gorge and rim samples are similar, in the Kaibab arch area, the difference in low-eU AHE and AFT ages is only 45 Ma at the bottom of the canyon and >100 Ma on the rim. This difference reflects pre-80 Ma residence of the basement samples in the gorge near the base of the fission-track PAZ, versus that of rim samples, which were at least 1500 m above the base of the PAZ. Thus, rim and gorge samples (points A and B, Figs. 4A and 4C) that were at much different temperatures prior to 80 Ma, reflecting their different paleodepths, converged in temperature and accordingly had a common depth and thermal history after 70 Ma. These data suggest that Campanian–Maastrichtian erosion of 1500 m in the canyon indicated by the AFT data was primarily incision downward through Mesozoic strata, creating a canyon of roughly the same depth as the modern one, cut in younger strata now eroded away (Flowers et al., 2008). This event was followed by a second pulse of unroofing in late

Oligocene or early Miocene time, which fairly evenly unroofed both gorge and rim down to erosion levels not far above the modern topography (Flowers et al., 2008).

Cooling History of Samples in the Western Grand Canyon Region

Apatite Fission-Track Ages

AFT ages from western Grand Canyon (Naeser et al., 1989; Kelley et al., 2001) and the Azure Ridge–Gold Butte area in the South Virgin Mountains (Fitzgerald et al., 1991, 2009) provide constraints on the cooling history not only of basement rocks at the bottom of Grand Canyon, where the time of incision is at issue, but also on nearby basement rocks overlain by at least 2500 m of Paleozoic–Tertiary overburden until 17 Ma (e.g., Brady et al., 2000).

In the vicinity of the mouth of Diamond Creek, the river bends 135° from a long S-flowing reach that transects the Coconino terrace to a NW-flowing reach parallel to the strike of the Arizona homocline (Figs. 1 and 2). There, the AFT age in basement rocks near the basal Cambrian unconformity is 75 ± 5 Ma, with a mean track length of 14.0 μm and relatively tight clustering (Fig. 4B, point D; Kelley et al., 2001). The best-fit thermal models of age and track-length distribution of this sample suggest rapid cooling from >110 °C to <65 °C in Campanian time, followed by residence somewhere between 20 and 50 °C after 60 Ma (Kelley et al., 2001). AFT ages of samples 25 and 50 km upstream to the north are younger (61 and 46 Ma, respectively; Kelley et al., 2001). Although no AHE age dating or thermal modeling has been done on these samples, they appear to have thermal histories more similar to the eastern Grand Canyon than to the sample near Diamond Creek.

In the Azure Ridge area of the South Virgin Mountains, ~10–20 km NW of the western terminus of Grand Canyon (Fig. 2), basement AFT ages from the steeply tilted fault block are consistently 17–15 Ma, up to a position 1–2 km structurally below the basal Cambrian unconformity, with tightly clustered track-length distributions >14.0 μm (Fitzgerald et al., 1991, 2009). Ages are progressively older structurally upward from this position, reaching 50 Ma just below the unconformity, with diffuse track-length distributions ranging from 12.0 to 13.2 μm (point C, Fig. 4B). In the area best constrained structurally (northernmost Azure Ridge area, Fig. 2; Brady et al., 2000), sample locations indicate that the 110 °C isotherm resided somewhere between 1000 and 1600 m below the basal Cambrian unconformity until 17 Ma, when the fault block was rapidly upended by extensional faulting. The 2500-m-thick Paleozoic–Tertiary

section in this fault block (Brady et al., 2000) indicates a pretilt depth range for the 110 °C isotherm of 3500–4100 m. Assuming a surface elevation near 2000 m at 17 Ma (Huntington et al., 2010) and a mid-Miocene surface mean annual temperature of 13–18 °C (discussed later herein), we can calculate a paleogeothermal gradient of 25 ± 3 °C/km, using the stated limits on depth and surface temperature as a conservative estimate of error.

A somewhat lower value of 20 °C/km was reported in two recent studies, primarily because they both assumed that the thickness of the Phanerozoic section above the basal Cambrian unconformity lies in the range 3500–4000 m, rather than the 2500 m value used here (Bernet, 2009, p. 182; Fitzgerald et al., 2009, p. 15). A value of 3500–4000 m is the correct value for the total Cambrian through Jurassic section, including a relatively thin section of disconformably overlying mid-Tertiary strata (Brady et al., 2000, p. 1379). However, in the fault blocks comprising the area from which the thermochronometric data were collected (Azure Ridge and environs, Fig. 2), the Tertiary unconformity is located near the basal Mesozoic unconformity, omitting some 1200 m of Triassic and Jurassic strata present farther north in the Virgin Mountains. Estimates of the distances between various PAZ and PRZ boundaries in the basement rocks, which do not depend on the estimate of sedimentary thickness, strongly support the 20 °C/km figure (Bernet, 2009; Fitzgerald et al., 2009). The disparity likely reflects a subtle but real increase in the gradient within the upper 5 km of the crust relative to that below, as predicted by model geotherms for the southwestern United States (e.g., Lachenbruch and Sass, 1978, their fig. 9–5). Hence, for the purposes of estimating erosion in the uppermost 3–5 km of the crust in this region, a gradient of 25 °C/km is appropriate (e.g., Quigley et al., 2010), whereas for estimates of the timing and amount of tectonic denudation for large fault blocks, values near 20 °C/km are more appropriate (Fitzgerald et al., 2009).

About 40–50 km north of the western terminus of the Grand Canyon in the North Virgin Mountains, extensive exposures of basement rocks along and beneath the basal Cambrian unconformity yield ages ranging from 23 to 10 Ma, i.e., much younger than ages in basement rocks in this position in the South Virgin Mountains (Quigley et al., 2010). Most of the ages range from 17 to 14 Ma. For these samples, nine measured mean track lengths range from 13.7 to 14.7 μm , averaging 14.0 μm (Fig. 4B). For an older group of ages from 23 to 19 Ma, mean track lengths on five samples range from 12.7 to 13.8 μm , averaging 13.2 μm . Based on

structural position and track-length modeling, the base of the PAZ in these samples lay <400 m below the basal Cambrian unconformity at 17 Ma, such that deeper samples yielding the younger group of ages were completely annealed prior to rapid mid-Miocene unroofing, and samples within a few hundred meters of the unconformity were acquiring tracks during relatively slow erosion in Oligocene and early Miocene time (Quigley et al., 2010). These data confirm the presence of additional overburden in the North Virgin Mountains relative to the South Virgin Mountains prior to Miocene unroofing, as expected from the presence of strata as young as Jurassic below the basal Tertiary unconformity in the area. They also confirm an estimate of the geothermal gradient at 17 Ma in the upper 5 km of the crust of 25 °C/km (Quigley et al., 2010; Fig. 4B).

Apatite (U-Th)/He Ages

The AHE age from a sample at the mouth of Diamond Creek (Diamond Creek pluton) is 75 ± 10 Ma (Fig. 5; Flowers et al., 2008). Although uncertain, it is concordant with the 75 ± 5 Ma AFT age determined by Kelley et al. (2001) from the same location, 25 m.y. older than the AFT age near the unconformity in the South Virgin Mountains and 55 m.y. older than AFT ages near the unconformity in the North Virgin Mountains. Regardless of the precise age of this sample, it is consistent with rapid cooling of the area below 65 °C in the Late Cretaceous, as indicated by track-length modeling (Kelley et al., 2001). Ages from two additional samples at river level ~15–20 km downstream from the mouth of Diamond Creek were also obtained (Fig. 2; Flowers et al., 2008). These samples occupy a structural position similar to the Diamond Creek sample, lying along the SW boundary of the Coconino terrace. As discussed further later herein, both of these samples and the Diamond Creek sample lie less than 10 km north of exposures of the unconformity between Paleozoic strata and Paleogene Rim gravels on

the Hualapai Plateau (Fig. 2; e.g., Elston and Young, 1991). These two samples yielded an uncertain age of 89 ± 7 (Separation Point batholith) and a better constrained age of 71 ± 3 Ma (245-Mile pluton, Fig. 5; Flowers et al., 2008). Based on the proximity of these three samples, and the similarity of their positions relative to the Colorado River, Coconino terrace, and Paleogene unconformity, the best estimate of the time of cooling below 70 °C in this area is 71 ± 3 Ma, or late Campanian to early Maastriichtian time. This age is 4 m.y. younger than, but overlaps within one standard deviation, the AFT age (point D, Fig. 4B), and overlaps within error the estimated age of rapid cooling in the Kaibab arch area of 75 ± 6 Ma (Dumitru et al., 1994; Kelley et al., 2001).

In the South Virgin Mountains, all AHE ages are 15–17 Ma, the shallowest of which is 900 m below the basal Cambrian unconformity. Because the base of the mid-Miocene PRZ for apatite is ~1300 m below the unconformity and the geotherm is 25 °C/km, the base of the mid-Miocene PRZ was located near the unconformity (point C, Fig. 4B; Reiners et al., 2000; Fitzgerald et al., 2009).

Comparison of the Diamond Creek Area with the South Virgin Mountains

Just as the estimate of pre-incision temperature difference between samples at different structural levels provides an estimate of the depth of incision in eastern Grand Canyon (Fig. 4C, curves A and B prior to 70 Ma), the postincision temperature difference between two samples on a common datum also provides a basis for estimating the depth of the canyon (Fig. 4C, curves C and D after 70 Ma). Collectively, the data indicate that for the westernmost Grand Canyon region, the temperature at the unconformity beneath the plateaus adjacent to the Grand Canyon at 17 Ma, and presumably for much of Tertiary time, was ~70 °C. Apatites at the mouth of Diamond Creek were clearly well below 70 °C at this time, but how much lower?

The fact that the basement AFT and AHE ages are about the same in the Diamond Creek area places strong constraints on the post-70 Ma (post-Campanian) thermal history. Because these apatites were above 110 °C at 75 Ma and cooled quickly below 65 °C on the basis of the AFT track-length data, they were completely annealed prior to cooling, and hence any damage would have occurred after 70 Ma. Thus, although some damage has occurred, these samples have low eU values and exhibit no dependence of age on eU (Fig. 5), as would be expected if post-70 Ma damage was having a significant effect on age (Flowers et al., 2007, 2008).

For apatites without significant radiation damage, residence at temperatures within the PRZ results in significant He loss and proportionate reduction in AHE age. The difference between the AFT age and the best constrained AHE age is $(75 \pm 5) - (71 \pm 3) = 4 \pm 6$ m.y. The difference between the AFT age and the mean age of the three AHE ages in the area (treating the 13 single-grain AHE ages as a single population) is $(75 \pm 5) - (75 \pm 4) = 0 \pm 6$ m.y. Clearly, more accurate data would be desirable. Nonetheless, the distributions of single-grain age determinations from three different igneous bodies in the area with low but variable eU (Fig. 5) are sufficient to show that further analyses would be unlikely to produce a population of AHE ages that, conservatively, average less than 60 Ma.

Helium loss in apatite with the low eU (<14 ppm) and relatively small grain radii (<60 μm) of the 245-Mile pluton is relatively severe, even at the cooler end of the PRZ. In forward models using the radiation-damage and annealing model (RDAAM) of Flowers et al. (2009) and the HeFTy software (Ketcham et al., 1999), apatites are cooled over a 10 m.y. period from 120 °C down to a temperature ranging from 20 °C to 50 °C, after which they are held at a constant temperature for a period of 70 m.y. The models predict that apatites retain nearly all He if they reside below 30 °C, but lose a substantial fraction of it above 30 °C (Fig. 6). The model ages depend strongly on the precise input parameters for the RDAAM model. For apatites residing between 30 and 40 °C, predicted ages vary by about ±10% over a range of acceptable input parameters based on experimental calibration (Fig. 6; see table 1 and fig. E4–4A in Flowers et al., 2009). For the 245-Mile pluton apatites, the oldest ages predicted by the model drop below 60 Ma at a residence temperature of 35 °C (Fig. 6), which thus represents a conservative upper bound on the post-70 Ma residence temperature of the sample.

Figure 5. Plot of single-grain apatite (U-Th)/He ages versus effective uranium concentration for three Lower Granite Gorge basement samples (data from Flowers et al., 2008). Sample locations are on Figure 2, keyed by age.

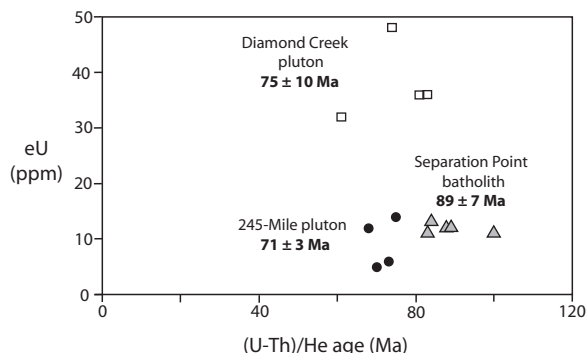
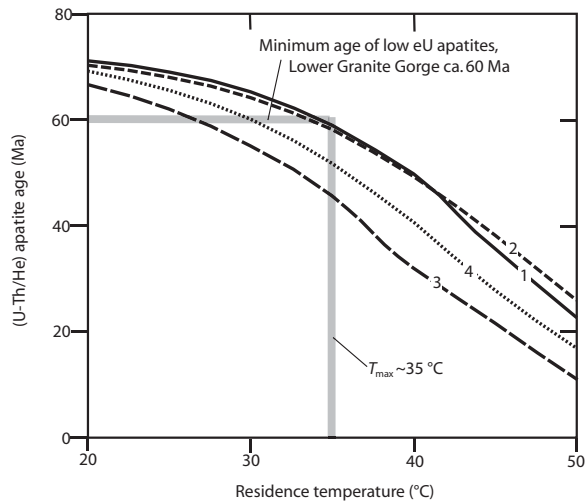

Figure 6. Curves showing apatite (U-Th)/He model age as a function of temperature for samples cooled rapidly from 120 °C and held isothermally for 70 m.y., for apatites with properties similar to the 245-Mile pluton sample (Figs. 2 and 5; eU = 14 ppm; grain radius = 60 μ m), using the radiation damage and annealing model (RDAAM) of Flowers et al. (2009). Curves labeled 1–4 correspond to parameter sets 1–4 given in table 1 of Flowers et al. (2009). All parameter sets predict ages younger than 60 Ma for residence temperatures above 35 °C.



This result must be qualified by the fact that the radiation-damage models are least certain at very low temperatures, which are farthest outside the range of experimental conditions on which the models are based (K.A. Farley, 2009, oral commun.). Therefore, although available data and models confirm that temperatures were below 35 °C for most of Tertiary time (e.g., Flowers et al., 2008), further studies of He distribution in Lower Granite Gorge apatites (e.g., using the $^4\text{He}/^3\text{He}$ method; Shuster and Farley, 2004) will be necessary to better quantify limits on the late Tertiary thermal history, which may include scenarios where the samples were somewhat warmer than 35 °C.

The salient point made by the concordance of the AFT and AHE ages is that if the only information available were the AHE ages, then they could be interpreted in terms of prolonged residence in the PRZ beginning at a time much earlier than 70 Ma, at temperatures below 70 °C but substantially higher than 35 °C, as is the case for the eastern Grand Canyon region. The fact that the temperature dropped soon before the recorded AHE age precludes this hypothesis. If correct, it in turn suggests a temperature difference of at least 35 °C existed between “plateau” (i.e., South Virgin Mountains) and Lower Granite Gorge basement samples at 17 Ma (Fig. 4C, curves C and D). The temperature difference corresponds to a canyon depth of no less than $(35\text{ °C})/(25\text{ °C}/\text{km}) = 1400\text{ m}$. This estimate is nearly all of the modern canyon depth of 1500 m, and similar to the minimum local paleorelief preserved beneath the Rim gravel unconformity nearby on the Hualapai Plateau (Elston and Young, 1991), discussed further in the following sections.

CENOZOIC ELEVATION AND CLIMATE ON THE SOUTHERN COLORADO PLATEAU

Stratigraphic and thermochronologic evidence for $\sim 1400\text{ m}$ of Late Cretaceous relief in the western Grand Canyon region and some 1500 m in eastern Grand Canyon suggest minimum Late Cretaceous elevations of at least these amounts for portions of the southwestern plateau (Young, 1979; Flowers et al., 2008). The apparent stability in the thermal histories of both regions through most of Tertiary time hints that elevation of this magnitude was maintained throughout the period.

After widespread Paleocene–Eocene aggradation of fluvial and lacustrine deposits on the plateau, but before integration of the upper and lower Colorado (the period from ca. 36 to 6 Ma), the plateau most likely experienced modest aggradational and erosional events, with the most pronounced erosion along the SW flank. This history is best illuminated in the central and southern plateau. There, aggradation of as much as 500 m of eolianites of the Chuska erg, downwind from Oligocene volcanic constructions along the southeastern margin of the plateau, occurred from 34 to 25 Ma, followed by their removal and further incision of a few hundred meters into their substrate (Cather et al., 2008). The erosion surface at 16 Ma beneath the Bidahochi Formation (Fig. 1) is as much as 1200 m lower in elevation than the highest preserved erg deposits $\sim 100\text{ km}$ to the east near the center of the plateau, suggesting that erosion between 25 and 16 Ma, including that of the erg deposits, could have been more than 1000 m (Cather et al., 2008). This figure is supported by sub-

Bidahochi AHE ages of 18–26 Ma along the SE margin of the area of Bidahochi deposition, confirming that kilometer-scale erosion affected at least this part of the basin between Chuska and Bidahochi time (Flowers et al., 2008).

Additional constraints bearing on mid- to late Tertiary elevation of the plateau are based on estimation of depositional temperatures of lake sediments in the Bidahochi Formation, and comparison with temperatures of paleolakes in adjacent lowlands (Huntington et al., 2010). Temperatures were determined using carbonate “clumped-isotope” paleothermometry, a new tool based on the relative enrichment of bonds between heavy isotopes (^{13}C – ^{18}O) in calcite and dolomite. This enrichment is a function of crystallization temperature, where development or “clumping” of heavy-isotope bonds decreases with temperature. A key advantage of this thermometer is that it is not dependent on assumptions about the isotopic composition of oxygen or carbon in surface waters (Eiler, 2007). To measure enrichment, CO_2 gas is evolved by acid digestion of the sample and then purified. The measured quantity is the relative abundance of CO_2 isotopologues (molecules of the same composition but differing mass) which contain one heavy isotope of oxygen and one of carbon. This isotopologue has mass $16 + 18 + 13 = 47$, and therefore the measured quantity is denoted as Δ_{47} (Ghosh et al., 2006; Eiler, 2007). Measurements from both modern and ancient samples deposited near sea level in the lower Colorado River basin were compared with the Bidahochi Formation, providing an opportunity not only to estimate changes in elevation of high-elevation samples relative to sea level, but also to quantify the influence of climate on depositional temperatures.

Measurements of Δ_{47} of modern lacustrine calcite deposited from 350 to 3300 m elevation in the southwestern United States suggest a lacustrine carbonate temperature (LCT) lapse rate of 4.2 °C/km with a zero-elevation intercept of 24 °C (Fig. 7). Limestones from the Bidahochi Formation ($\sim 1900\text{ m}$ above sea level) record temperatures of 22–25 °C, 8 °C warmer than the temperature predicted by the modern LCT trend, perhaps implying significant post-6 Ma uplift. However, limestones measured in the low-standing Colorado River trough (Bouse Formation and Hualapai Limestone) cluster around an average value of 30.5 °C, except for two samples from the southernmost part of the basin (Fig. 7). These samples yielded temperatures 6–8 °C cooler, which are interpreted to result from the influence of a nearby marine climate on lake surface temperatures (Huntington et al., 2010). Linear regression of all the ancient samples except for the southernmost group

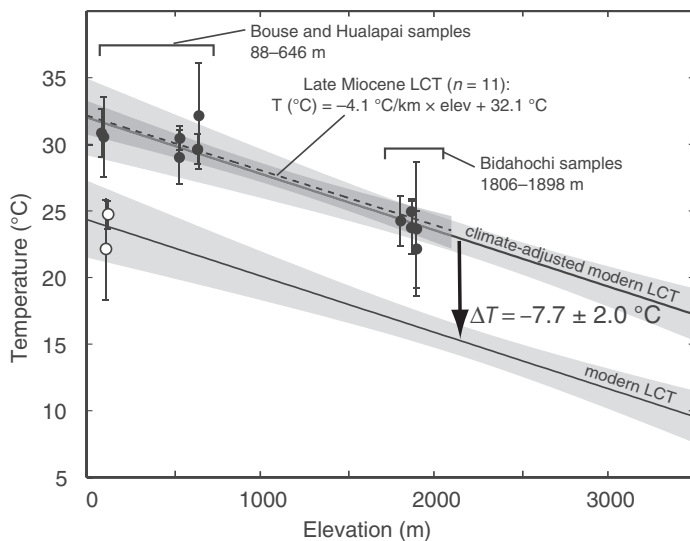

Figure 7. Carbonate clumped-isotope thermometry temperature estimates versus modern elevation for samples collected in the Colorado River basin (after Huntington et al., 2010). Data points marked by unfilled circles are interpreted to reflect cooling of lake surface temperatures due to the influence of marine climate near the late Miocene delta. Inland samples define a lacustrine carbonate temperature (LCT) lapse rate for the late Miocene similar to the modern LCT lapse rate, suggesting little or no elevation adjustment of the southwestern Colorado Plateau since 16 Ma. Vertical arrow shows apparent 8 °C of cooling of lake depositional temperatures since 6 Ma, interpreted to reflect climatic cooling.

the 17 Ma surface MAT on the westernmost plateau. Assuming the surface was at 2000 m elevation, surface MAT in the Miocene would have been the present value of 10 °C plus 3–8 °C to adjust for cooling of the climate.

High elevation of the plateau during Muddy Creek/Bidahochi time is further supported by the depositional geometry of the Muddy Creek Formation against the Grand Wash Cliffs (Fig. 3). Near the western terminus of Grand Canyon, Muddy Creek strata lie in buttress unconformity against the cliffs. The Muddy Creek was probably not deposited substantially below sea level (cf. Lucchitta, 1979), as suggested by (1) the similarity in depositional temperatures between the Hualapai Limestone and Bouse Formation (Fig. 7; Huntington et al., 2010); (2) the requirement of north-to-south hydrological flow between the Hualapai and Bouse basins (e.g., Spencer et al., 2008a); and (3) the rarity of active nonmarine deposition below sea level. The elevation difference between the lowest exposures of Muddy Creek at river level and the Shivwits Plateau immediately east of Grand Wash Cliffs is 1600 m (Fig. 3), which represents a minimum estimate of the elevation of the west-central margin of the plateau in mid-Miocene time.

PROVENANCE OF LATE CRETACEOUS–PALEOGENE DEPOCENTERS

Grand Canyon Region

Rim Gravels South of Grand Canyon

The Rim gravel deposits are typically ~100 m thick on the plateau, and are preserved to within 50 km SW of the rim of eastern Grand Canyon and to within <10 km of the Colorado River in western Grand Canyon (Figs. 1 and 2; Elston and Young, 1991; Young, 2001a). They contain clasts of volcanic rocks with predominantly Late Cretaceous K–Ar ages (mainly 80–64 Ma; Elston et al., 1989). They also contain detrital grains with AHE ages as young as 50 Ma, and lie on a substrate with AHE ages as young as 53 Ma. Thus, on the basis of thermochronological data alone, deposition occurred in early Eocene or later time (Flowers et al., 2008).

Lacustrine carbonates within the Rim gravels contain a nonmarine invertebrate fauna similar to that of the well-dated Paleogene fluvial and lacustrine strata along the NE flank of the Arizona homocline in southern Utah and elsewhere in western North America (Young, 1999). On this basis, they have been regarded as early Eocene in the Long Point area (Fig. 1) and possibly as old as Late Cretaceous in other areas (Young, 1999, 2008). Thus, in combination

yields a zero-elevation intercept of 32 °C and a paleo-LCT lapse rate of 4.4 °C/km (Fig. 7).

Because the mean annual temperature (MAT) lapse rate is relatively insensitive to climate change under generally arid conditions at middle latitudes, these data suggest a history of little or no elevation change for any of the samples since 6 Ma. The 8 °C difference in temperature between the modern and ancient samples at any given elevation suggests that the Miocene climate, at least as revealed in lake-surface temperatures, was substantially warmer than today's climate, an observation consistent with the glacial conditions of the Quaternary versus the nonglacial conditions of the Miocene, as well as other proxies for paleoclimate in the western interior (e.g., Zachos et al., 2001; Cather et al., 2008; Chapin, 2008; Young, 2008, and references therein). Further, the consistency of temperatures between 16 Ma limestones and 6 Ma limestones within the Bidahochi Formation suggests at best only small changes (<2 °C) since 16 Ma; this is also consistent with the contrast between generally nonglacial times and the Quaternary. These results are not consistent with surface uplift estimates based on basalt vesicle altimetry on Pliocene basalts on the plateau in east-central Arizona, which suggest more than

1000 m of uplift (Sahagian et al., 2003; see discussion in Huntington et al., 2010), but they are consistent with the hypothesis that kilometer-scale relief in the southwestern portion of the plateau had developed by latest Cretaceous time (Flowers et al., 2008; Huntington et al., 2010).

The 8 °C cooling in the LCT curve may overestimate the change in MAT since Miocene time, if seasonality were more pronounced then. Lacustrine carbonate temperatures primarily reflect late spring/early summer lake-surface temperatures, so it is possible that a significant component in the rise of LCT temperatures could occur without commensurate increase in MAT (Huntington et al., 2010). Further, ongoing studies of low-elevation modern lakes in the region suggest a somewhat higher modern LCT lapse rate and sea-level temperatures than estimated from the more limited data set of Huntington et al. (2010; J. Thompson, J. Eiler, 2010, personal commun.). Ocean-surface temperatures through much of Tertiary time were ~3 °C warmer than during the Quaternary (e.g., Zachos et al., 2001). Given the continental setting of the plateau, conservative limits on the Tertiary MAT would, therefore, be between 3 and 8 °C warmer than today. These data provide a basis for the estimate in the previous section of

with the apatite He data, the depositional age is early Eocene (Flowers et al., 2008). Young and McKee (1978) suggested that the basal unconformity on the Rim gravels represents a Late Cretaceous–Paleogene drainage network upstream from the Paleogene deposits in southern Utah. Based on radiometric ages in Rim gravels in the Fort Apache region (Potochnik and Faulds, 1998) and on paleontological grounds, however, Cather et al. (2008) regarded the Rim gravels in the Hualapai Plateau area as part of a plateau-wide period of aggradation of late Eocene to early Oligocene age, as described in the previous section.

Adjacent to the Arizona Transition Zone in the Peach Springs area, the gravels fill paleocanyons incised deeply into the Hualapai Plateau (Figs. 2 and 8; Young, 1979). Prior to Rim gravel deposition, the paleocanyons had incised downward to create local relief of at least 1200 m (vertical measurement 1, Fig. 8). Net aggradation of as much as 300 m occurred between the early Eocene and the eruption of 19 Ma basalts near the top of the section (Separation Canyon basalt, Fig. 8). Paleocurrent indicators and the provenance of the gravels indicate overall NE transport, from the Arizona Transition Zone toward the plateau (Young, 1966). Since 19 Ma, these channels were variably reincised, reexposing their bottoms. Modern southern tributaries to western Grand Canyon, including Milkweed,

Hindu, and Peach Springs canyons (Fig. 2), are locally cut very close to the sub–Rim gravel unconformity (Elston and Young, 1991; Young 2001a; Fig. 8).

The lowest preserved exposures of the Peach Springs–Truxton paleocanyon come to within 8 km of Grand Canyon, where both the modern and ancient channels drain to the NNE (Figs. 2 and 8; Billingsley et al., 1999). The bottoms of the ancient channels lie at modern elevations of between 830 and 1000 m, and now slope very gently SW, opposite to the NE depositional paleoslope (Young, 2001a). A minimum of 0.8° of SW tilting (opposite the NE dip of the Hualapai Plateau Paleozoic section) after deposition of the gravel is necessary for the base of the channel network to have been initially horizontal, taking into account some 170 m of late Cenozoic offset on the Hurricane fault zone in the area (Fig. 8; Young, 2001a).

The existence of a Paleogene stream channel within a few kilometers of the Colorado River, which in modern exposures is cut to within 600 m of the modern river grade, speaks to the antiquity of portions of the modern landscape (Young, 1979, 2008; Elston and Young, 1991; Karlstrom et al., 2007), and is problematic for any model wherein western Grand Canyon incision is primarily younger than 6 Ma (e.g., Lucchitta and Jeanne, 2001). The Rim gravel exposures at 1000 m elevation

in Peach Springs Canyon lie in a fault block along the trace of the Hurricane fault and are substantially lower than exposures east and west of the fault zone, which lie at ~1300 m elevation (Billingsley et al., 1999), and hence movements along the fault zone during both late Cenozoic and Laramide time complicate estimates of the position of the river channels relative to the modern Colorado River grade a short distance to the north. Given the modern elevation of the lowest gravels and the elevation of gravels east and west of the fault zone as bounds on the position of the ancient channels, they would intersect the Colorado at a modern elevation between 1050 and 1350 m at the mouth of Diamond Creek (Figs. 2 and 8). The projected intersection is as much as 400 m below the mean elevation of the Hualapai Plateau (vertical measurement 2, Fig. 8) and as much as 750 m below the Shivwits Plateau immediately to the north of Grand Canyon (vertical measurement 3, Fig. 8; Young, 1985). This constraint appears to limit any post–36 Ma incision of Grand Canyon to between 700 and 1000 m at Diamond Creek (vertical measurement 4, Fig. 8). However, as described already, a residence temperature of <35 °C for basement samples suggests that even with a minimum of 700 m of post-Eocene erosion, substantial He loss would have occurred after 70 Ma, which is treated in more detail in following sections.

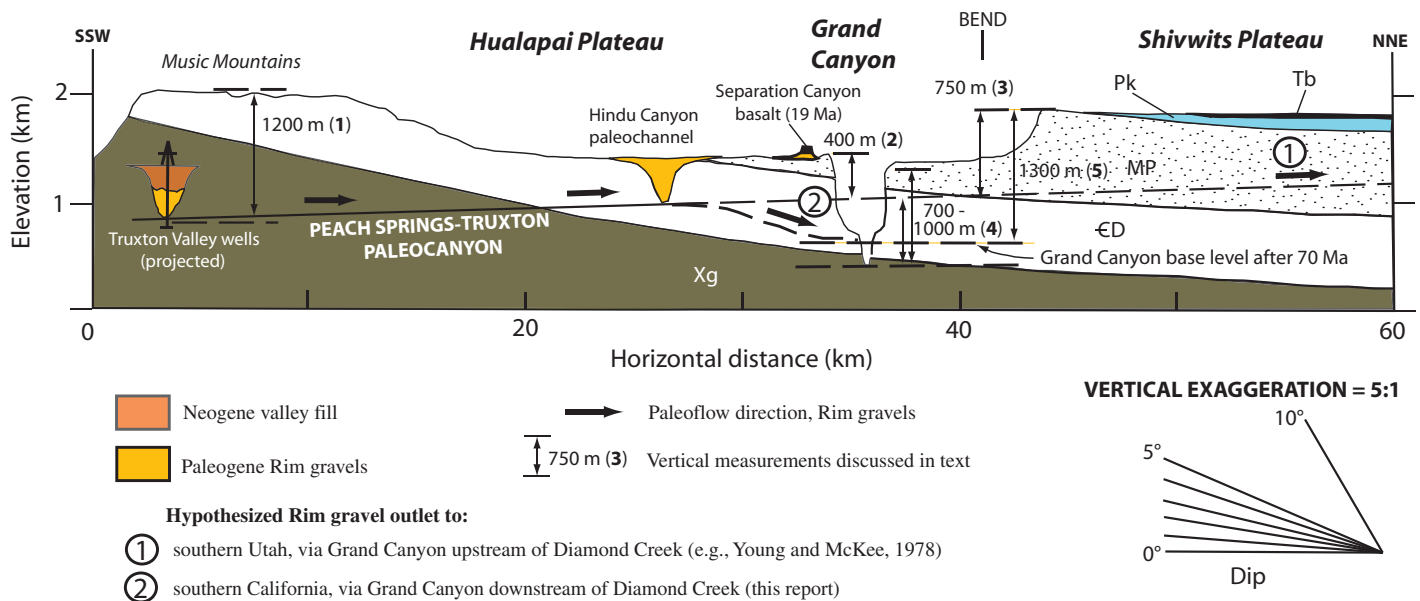

Figure 8. Cross section through the western Grand Canyon region showing geometric relationships between various geomorphic and geologic features discussed in text (based on Young, 1982). Xg—Proterozoic crystalline basement; CD—Cambrian and Devonian strata; MP—Mississippian to Permian strata; Pk—Permian Kaibab Formation; Tb—8 Ma Shivwits basalts. Vertical arrows show measurements of elevation differences discussed in text. Hindu Canyon channel depicted assuming present minimum elevation of Rim gravel deposits in Peach Springs Wash (1000 m) has not been modified by faulting (see text for discussion).

Comparison of Rim Gravels with “Canaan Peak–Type” Gravels North of Grand Canyon

Numerous undated gravel deposits exposed north and west of Grand Canyon provide a potential link between the Rim gravels and coeval deposits in southern Utah (e.g., Elston et al., 1989). Reconnaissance studies of these “Canaan Peak–type” gravels indicate important contrasts with the Rim gravels (e.g., Hill and Ranney, 2008). Rim gravels are typically cemented and preserved intact, and have a variably rounded, diverse clast assemblage. It includes Proterozoic basement, Paleozoic cover rocks, and Late Cretaceous volcanic rocks that record unroofing of the Arizona Transition Zone and areas to the SW, via a NE-flowing drainage network (e.g., Young, 1999, 2001b). Canaan Peak–type gravels are typically exposed as unconsolidated lag deposits on the modern erosion surface, and consist primarily of varicolored, well-rounded quartzite pebbles and cobbles, interpreted by Hill and Ranney (2008) to be recycled from the Maastrichtian–early Paleocene Canaan Peak Formation of southern Utah on the basis of their macroscopic appearance. The quartzite clasts in the Canaan Peak contain distinctive chert litharenite and black chert clasts containing microfossils that can be directly linked to the Mississippian Eleana Formation to the west in southern Nevada (Goldstrand, 1990). Because it is possible that these deposits are entirely post–6 Ma in age, they do not as yet place any firm constraints on the paleohydrology of the region prior to development of the modern Colorado River.

Strata Upstream of Grand Canyon in Utah

In southern Utah (Kaiparowits Plateau and environs, Fig. 1), extensive exposures of Upper Cretaceous to Eocene deposits provide a detailed record of the evolution of drainage and tectonism. Through Campanian time, these deposits record primarily fluvial deposition of far-traveled sand and mud, with alternating episodes of NE (longitudinal to the Sevier orogen) and SE (transverse) transport (Fig. 9A; Lawton et al., 2003). These deposits have variable sources, including detritus from the Sevier orogen and a high plateau region immediately to its west in Nevada and Utah (“Nevadaplano” of DeCelles, 2004; Fig. 9A), and the nascent Mogollon Highlands in Arizona (Dickinson and Gehrels, 2008). Their deposition was followed in Maastrichtian to early Paleocene time by deposition of the Canaan Peak and Castle Gate formations, which contain bouldery gravels and are dominated by E- to ENE-directed flow (Goldstrand, 1992). By Paleocene to early Eocene deposition of the overlying Pine Hollow Formation, regional

transport of far-traveled sands and gravels was replaced by accumulation of locally derived material, recycled from underlying formations, in basins trapped within gentle Laramide synclines (Goldstrand, 1994; Larsen, 2007). This was followed by time-transgressive deposition of post-tectonic basal sands and gravels of the Claron Formation from late Paleocene to middle Eocene time, which exhibit evidence of overall southward transport (Fig. 9B). The sands and gravels are succeeded by deposition of lacustrine marl (red Claron) and then limestone (white Claron) that prevailed through at least middle Eocene time and possibly into the late Eocene (Goldstrand, 1990, 1994).

The pre–Canaan Peak Cretaceous strata contain detrital zircon populations for which the youngest ages are about the same as the depositional age through most of the Campanian epoch. Three stratigraphic levels yield, from bottom to top, minimum age peaks at 82, 77, and 73 Ma, indicating strong input from the active Cordilleran magmatic arc to the SW (Larsen, 2007; Jinnah et al., 2009; Larsen et al., 2010). The youngest of these levels, the Kaiparowits Formation, has an unusual signature. In contrast to enveloping strata, which contain large components of Paleozoic and Precambrian zircon, the Kaiparowits is predominantly arc-derived.

Surprisingly, following this pulse of sediment derived from the active arc, the youngest zircons in the overlying Canaan Peak are 103 Ma, indicating that the active-arc source was cut off from the region by Maastrichtian time (Larsen, 2007; Link et al., 2007; Larsen et al., 2010). The 103 Ma age, combined with the onset of deposition of coarser material, strongly suggests derivation of at least part of the Canaan Peak from sources less distant than the active arc, including the mid-Cretaceous Delfonte volcanics in the eastern Mojave region of southern California (Goldstrand, 1990; Larsen, 2007).

A sparse component of Campanian zircon is found in the Paleocene–lower Eocene Pine Hollow Formation. These few grains (only five total), nonetheless, exhibit an age progression in a reversed order from that observed in the Campanian section, becoming progressively older from bottom to top, with ages of 71, 78, and 81 Ma (Larsen, 2007). Using paleocurrent data and characteristics of modern erosion patterns in these units, the detrital zircon data from the Pine Hollow Formation were interpreted by Larsen (2007, his fig. 15) to reflect local recycling via unroofing from a developing anticline (e.g., Burbank et al., 1988). In contrast to the Pine Hollow Formation and all older units, the post-tectonic Claron Formation did not yield any Cretaceous zircons. The youngest

zircon age peak from a sample from the lower siliciclastic part of the Claron is Late Jurassic (>150 Ma), suggesting the return of a relatively distant source, most likely Cordilleran/Rocky Mountain sources to the north and west rather than California sources to the SW (Larsen, 2007; Link et al., 2007; Larsen et al., 2010).

Along the northern margin of the Colorado Plateau in the Uinta Basin, detrital zircons in the Paleocene–Lower Eocene Colton Formation exhibit a signature similar to the Kaiparowits Formation, with derivation almost exclusively from the arc (Davis et al., 2010), which is in turn quite similar to the signature from a sample of the Cretaceous portion (post–79 Ma) of the McCoy Mountains Formation in west-central Arizona (Davis et al., 2010; Spencer et al., 2011), located within the Mojave/Mogollon Highlands region. Thus, in marked contrast to the Maastrichtian cutoff in the supply of arc-derived material in the southern Utah basins (Larsen et al., 2010), the northern margin of the plateau continued to receive arc detritus.

Strata Downstream of Grand Canyon in Southern California

Tectonic Setting and Depositional Substrate

Tectonic reconstruction of the right-lateral San Andreas transform restores the distinctive latest Cretaceous–Paleogene depocenters of the Western Transverse Ranges of southern California and Salinian terrane in central California to a position due SW of the Grand Canyon region at 6 Ma and earlier times (e.g., Howard, 1996; Atwater and Stock, 1998). The restored belt of these terranes is 500 km long, approximately aligning it with the 500-km-long Arizona Transition Zone and environs (Figs. 1 and 9; e.g., Saleeby, 2003; Jacobson et al., 2010).

After reconstruction, to the NW and SE of the Transition Zone, a broad Cretaceous forearc basin is well preserved to the west of the Cordilleran arc, including a concordant Upper Jurassic through Eocene section as much as 15 km thick (e.g., Ingersoll, 1982; Fig. 9B). In the Western Transverse Ranges and Salinian terrane, there is a stark contrast. Pre-Maastrichtian deposits are either thin or absent, and a concordant Maastrichtian through Eocene section as much as 8 km thick rests nonconformably on Late Cretaceous arc plutons and pre-Cretaceous crystalline rocks as old as Early Proterozoic (e.g., Chipping, 1972; Grove, 1993).

The tectonic elements characterizing the Cretaceous arc NW and SE of the thick Maastrichtian–Eocene depocenter include five distinct, laterally persistent belts, from SW to NE (Fig. 9A; e.g., Dickinson, 1981; Ingersoll, 1998; Saleeby, 2003): (1) a subduction complex;

Figure 9. Paleogeographic maps showing: (A) Campanian position of California River drainage near the onset of incision in the Grand Canyon region. Red line shows position of drainage divide; black arrows show paleocurrent directions of the Wahweap Sandstone from Lawton et al. (2003), along with hypothetical position of drainage transverse to the Sevier orogen. Sevier uplands and hypothetical “Nevadaplano” high plateau are from DeCelles (2004). (B) Early Eocene positions of Arizona River drainage, the drainage system in the Fort Apache region (Potochnik, 2001), and ancestral Gila and Amargosa Rivers (Howard, 1996). Palinspastic base and direction of plate convergence are after Saleeby (2003). Position of drainage divide in Nevada is from Henry (2008). Abbreviations highlighted with yellow background correspond to locations in Figure 13 as follows: LA—Los Angeles; N—Needles; K—Kingman–Lake Mead area; WG—western Grand Canyon; EG—eastern Grand Canyon; GC—Glen Canyon.

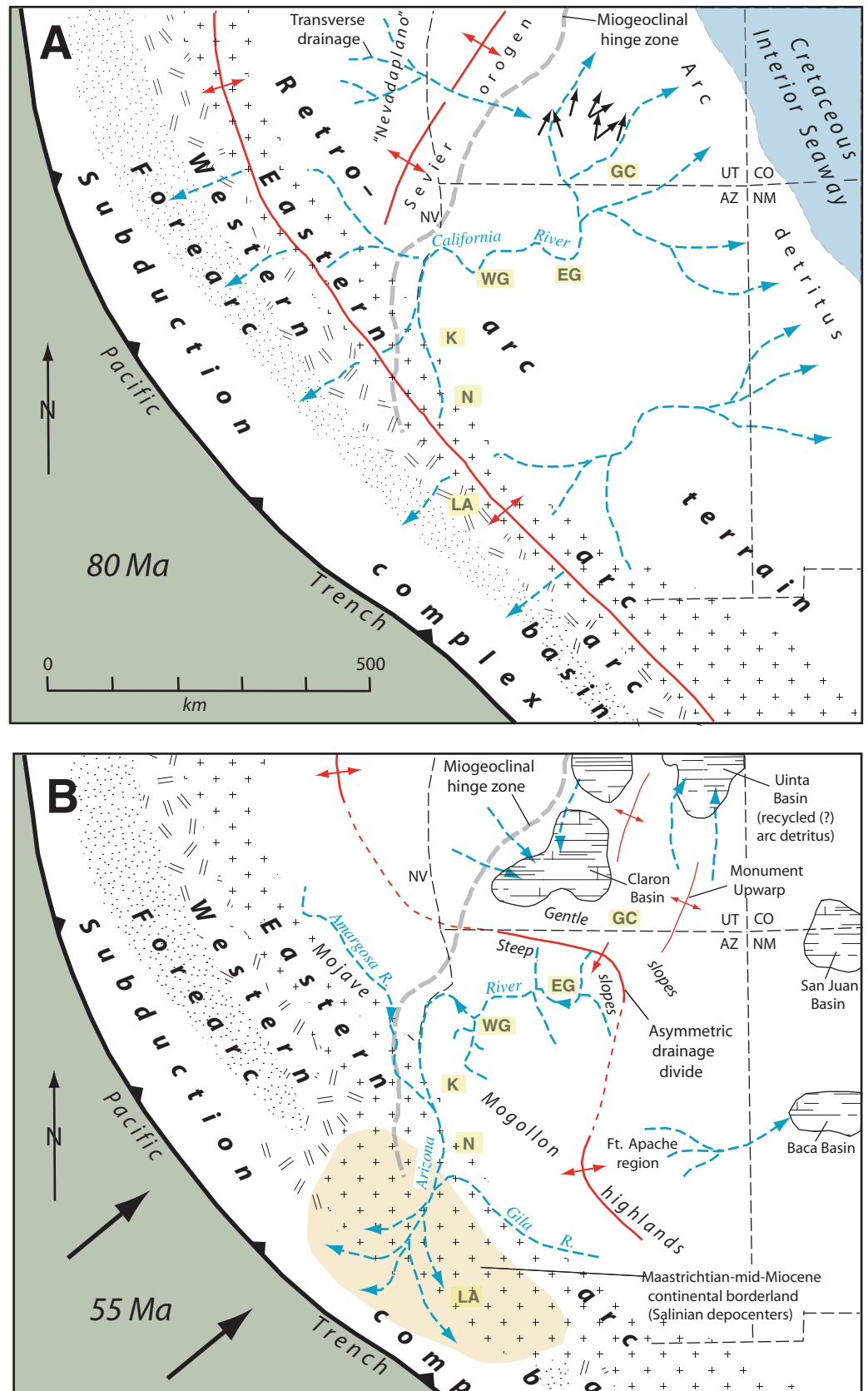

(2) tectonically overlying forearc basin strata; (3) primarily Early Cretaceous tonalitic western arc plutons intruding a Jurassic and older ensimatic arc framework; (4) Late Cretaceous granodioritic to granitic eastern arc plutons, which intrude metamorphic equivalents of rocks behind the arc and associated volcanic strata as young as 70 Ma; and (5) an ensialic retroarc belt, which contains a depositional hinge zone between Paleozoic shelf deposits to the NW (Cordilleran miogeocline) and cratonic deposits to the SE. The hinge zone is oriented at a high angle to the Cretaceous arc, running from just NW of Grand Wash Trough to its intersection with the arc in the central Mojave Desert (e.g., Martin and Walker, 1992; Fig. 9). Hence, the modern Colorado River basin is developed mostly SE of the hinge in the cratonic portion of the retroarc foreland.

Southwest of the Arizona Transition Zone, beginning in Campanian time, tectonic events along the continental margin severely disrupted the system, resulting in the juxtaposition of the eastern arc directly against the subduction complex. The juxtaposition at upper-crustal levels is best expressed in the Coast Ranges of central California along the Nacimiento fault zone (e.g., Page, 1981). At deeper crustal levels, the eastern arc is underthrust by metamorphosed Upper Cretaceous though Eocene trench deposits (Pelona, Orocopia, and Rand schist complexes; e.g., Saleeby, 2003; Jacobson et al., 2010). These juxtapositions have been attributed by some workers to tectonic erosion along the Cretaceous trench, which sheared off and subducted the forearc and western arc, replacing it with trench deposits at both shallow and deep crustal levels (e.g., Saleeby, 2003). An alternative model attributes the juxtaposition at shallow structural levels to large-magnitude, left-lateral strike-slip along the Nacimiento fault (Dickinson, 1983; Dickinson et al., 2005), which may also account for the southward migration of deposition and metamorphism of the Pelona and related schists, from >90 Ma to the north to <60 Ma to the south (Jacobson et al., 2010).

Regardless of the degree to which thrusting or strike-slip faulting contributed to these juxtapositions, the Late Cretaceous nonconformity exposed at high structural levels in the eastern arc records a dramatic transition in setting, from an earlier, inboard position along the axis of the Cordillera, to an extending and rapidly subsiding continental borderland (e.g., Grove, 1993; Saleeby, 2003; Jacobson et al., 2010). The marine embayment in the continental margin resulting from this transition (e.g., Saleeby, 2003) began to focus drainages into the region, resulting in thick accumulations of terrigenous detrital sediment (Fig. 9B).

Provenance

In the newly developed borderland basins, Maastrichtian strata are dominated by arc-derived material. Gravels at the base are angular and derived from the local basement, but they mature upward to include well-rounded meta-rhyolite clasts and, in some sections, clasts of metaquartzite similar to Cambrian metaquartzites within framework rocks of the eastern arc (Colburn and Novak, 1989; Grove, 1989).

Upper Paleocene and Eocene conglomerates farther upsection record a significant change in provenance. In Upper Paleocene strata lying above a regional unconformity (Runyon Canyon surface of Colburn and Novak, 1989) and below a tuff horizon dated at 56 Ma, unmetamorphosed quartz arenite clasts (orthoquartzites) become abundant, and remain common in virtually all conglomerates (Colburn and Novak, 1989; Howard, 1996, 2000). In an upper-middle Eocene (Uintan) portion of the Sespe Formation (Whistler and Lander, 2003), comparison of the petrology of orthoquartzite clasts with that of orthoquartzites in likely source regions demonstrates a strong tie to the Ediacaran–Lower Cambrian Stirling, Wood Canyon, and Zabriskie Formations to the NW of the miogeoclinal hinge zone, and to the Lower Cambrian Tapeats Sandstone on the craton (Howard, 2000). Although these units occur locally within the eastern arc as metamorphosed wall rocks, preservation of unmetamorphosed sections is largely restricted to the retroarc belt. The transition from local to exotic, beginning in the Maastrichtian but culminating with the arrival of orthoquartzite clasts in the Paleocene, confirms a long-held view that the coastal drainages opposite the Transition Zone expanded northeastward and became increasingly integrated in latest Cretaceous and early Tertiary time (e.g., Woodford et al., 1968; Kies and Abbott, 1983; Grove, 1993; Howard, 2000). Thereafter, tectonic events associated with the growing transform margin (Atwater and Stock, 1998; McQuarrie and Wernicke, 2005) resulted in a cutoff of input from exotic sources at ca. 15 Ma, and a return to local derivation (including recycling of earlier orthoquartzites) during deposition of the Puente, Monterey, and equivalent formations along the active transform (Critelli et al., 1995; Ingersoll and Rumelhart, 1999).

The consistency in provenance from the eastern arc/retroarc region from early Paleocene to mid-Miocene time, and the fluviodeltaic depositional facies of these deposits led Howard (1996, 2000) to conclude that a “Colorado paleoriver,” located at about the same place as the modern Colorado River NE of the San Andreas fault near Yuma, Arizona, existed throughout most of

Tertiary time, and terminated in coastal basins now preserved in the southern Coast Ranges, Western Transverse Ranges, and Peninsular Ranges of California. The active coastal delta system lost connection to inland sources by the formation of the San Andreas system, which resulted in transfer of deposition from the now-offset Los Angeles area to the rapidly opening Gulf of California over the last 6 m.y. Howard (1996) suggested that the system had two primary branches, one reaching to the NW from the delta and tapping sources in the Death Valley region (his “Amargosa-Colorado paleoriver”), and another reaching to the SE (“Gila-Colorado paleoriver”), tapping distinctive sources in SE Arizona and Sonora, Mexico (“Poway-type” clasts), as documented by Kies and Abbott (1983). Howard (1996, p. 785) raised the possibility that the source of the Sespe clasts could also have been an early Tertiary paleo-Grand Canyon, because the petrographic match with the Tapeats Sandstone is especially strong. Indeed, Grand Canyon currently contains its most extensive area of exposures, and the localization of a main-stem river within a large area of outcrop of Tapeats Sandstone would make its most survivable subunits a prominent component of the ancient river’s bed load. However, other potential sources for Tapeats clasts in eastern California and Arizona are possible, and following community consensus, Howard (1996) felt the hypothesis was precluded because pre-mid-Miocene erosion levels in Grand Canyon had not reached the level of the Tapeats Sandstone during Sespe time.

Restriction of the Sespe source region to areas SW of the modern Colorado Plateau is supported by comparison of detrital zircon populations in late Paleozoic and early Mesozoic erg deposits that are widespread on the plateau and detrital zircon populations in the Sespe Formation. Whereas Appalachian- and Grenville-age zircons (ca. 0.4–1.3 Ga) are abundant in the erg deposits (Dickinson and Gehrels, 2003, 2009), they are lacking in the Sespe Formation (e.g., Spafford et al., 2009). Hence, if the Sespe headwaters did reach as far NE as the Grand Canyon area, it would be conditional on the source region lacking extensive exposures of the erg deposits.

In this light, the modern western Grand Canyon would remain a potential source area, because (1) the primary Paleozoic erg deposit (Coconino Sandstone) pinches out beneath the Kaibab Limestone in western Grand Canyon, where it is either absent or at most a few tens of meters thick (e.g., Wenrich et al., 1997); and (2) Lower Mesozoic erg deposits (Navajo and related sandstones) are omitted across the unconformity at the base of the Rim gravels, which

rest on pre-Navajo strata throughout the region (Fig. 1; e.g., Billingsley et al., 1999). In these respects, western Grand Canyon is more akin to the “erg-poor” Mojave/Mogollon Highlands source region than it is to the “erg-rich” source areas throughout the remainder of the plateau.

It is noteworthy that Ediacaran–Cambrian orthoquartzite clasts abundant in Sespe gravels likely contain a substantial component of Grenville-age (1.0–1.3 Ga) zircons (Stewart et al., 2001). Thus, even though Ediacaran–Cambrian units constitute ~10%–30% of the gravel fraction of the Sespe and are widely exposed in the Mojave/Mogollon Highlands region (Howard, 1996, 2000), they did not make a measurable contribution to detrital zircon populations recovered from Sespe sandstones (Spafford et al., 2009).

SYNTHESIS

Erosion History of Western Grand Canyon

Given an apparent upper limit of 35 °C for the temperature of western Grand Canyon basement in the Diamond Creek area since 70 Ma, it seems possible that the erosion level may indeed have reached as deeply as the Tapeats Sandstone, as early as Late Cretaceous time. If so, it expands the potential reach of Howard’s (2000) already extensive (~400-km-long) paleoriver systems into the SW margin of the plateau in NW Arizona. This hypothesis predicts post-Campanian (post-70 Ma) erosion in western Grand Canyon to have been less

than ~300 m, the maximum depth of incision of western Grand Canyon below the top of the Tapeats Sandstone. If correct, it has a broad range of implications for the origin of Grand Canyon and the paleohydrology of the southwestern United States. A 70 Ma erosion surface, if very close to the modern one at the bottom of western Grand Canyon, has the same implications as would a discovery of Campanian river gravel deposits near the modern river grade. The key question is, using thermochronological data as a proxy, at what level in western Grand Canyon can we claim such deposits once existed?

To first order, given a nominal surface temperature of 20 °C and geotherm of 25 °C/km, the upper limit of erosion is ~600 m. A figure of roughly this amount is independently suggested by the northward projection of the Peach Springs–Truxton paleocanyon, which suggests no more than 700–1000 m of erosion after 36 Ma at the latest (vertical measurement 4, Fig. 8).

We can better estimate the post-70 Ma erosion history of western Grand Canyon by synthesizing (1) estimates of the mid-Tertiary geotherm, (2) modern measurements of temperature in the shallow subsurface in the region, (3) the difference between Quaternary and Tertiary MAT, and (4) estimates of Tertiary paleoelevation in the region.

In the upper ~1000 m of the crust, the temperature T_{\max} at a maximum sample depth z_{\max} through Tertiary time is

$$T_{\max} = T_{s, h70} + (dT/dz)z_{\max}, \quad (1)$$

where $T_{s, h70}$ is the surface temperature above the sample at the onset of erosion at 70 Ma, and dT/dz is the geothermal gradient (a positive number), assumed to remain relatively steady during the small amount of slow erosion inherent to the problem (Fig. 10).

At present, shallow surface temperatures vary as a function of surface elevation h according to

$$T_s(h) = T_{h=0} + (dT_s/dh)h, \quad (2)$$

where $T_{h=0}$ is the present surface temperature at sea level, and dT_s/dh is the lapse rate of surface temperature as a function of elevation (a negative number; Fig. 10).

The relationship between changes in surface air temperature and the near-surface geotherm is complex (e.g., Section 2.6 in Carslaw and Jaeger, 1959), but for our purposes, we note that surface temperature changes due to long-term climate change ΔT (a negative number for cooling) are small relative to the depth over which they perturb the geotherm. This is not true for century-scale climate variations, which are of order 1.0 °C and occur over a depth range of 0–100 m, affecting temperature only modestly, but affecting dT/dz by as much as a factor of 2 (e.g., Chisholm and Chapman, 1992). However, in our case, we are dealing with a boundary temperature change ΔT in the range 3–8 °C applied over a time scale of at least 2 m.y. The depth of influence L of a boundary perturbation ΔT scales as $L \sim 2(\kappa t)^{1/2}$, where κ is thermal conductivity, and t is the time since the perturbation. For thermal conductivity of 10^{-6} m²/s and $t =$

Figure 10. Plot showing temperature versus sample depth (left) and diagrammatic columns showing the definitions of variables in Equation 4 (right). Plot illustrates five-step graphical procedure to estimate maximum paleodepth z_{\max} for shallow samples, given an upper bound of temperature T_{\max} from thermochronology. Adjustments from the modern sample elevation and surface temperature (step 1) include climate change (step 2), rock uplift (steps 3 and 4), and the effect of elevation on surface temperature (step 5). See text for discussion.

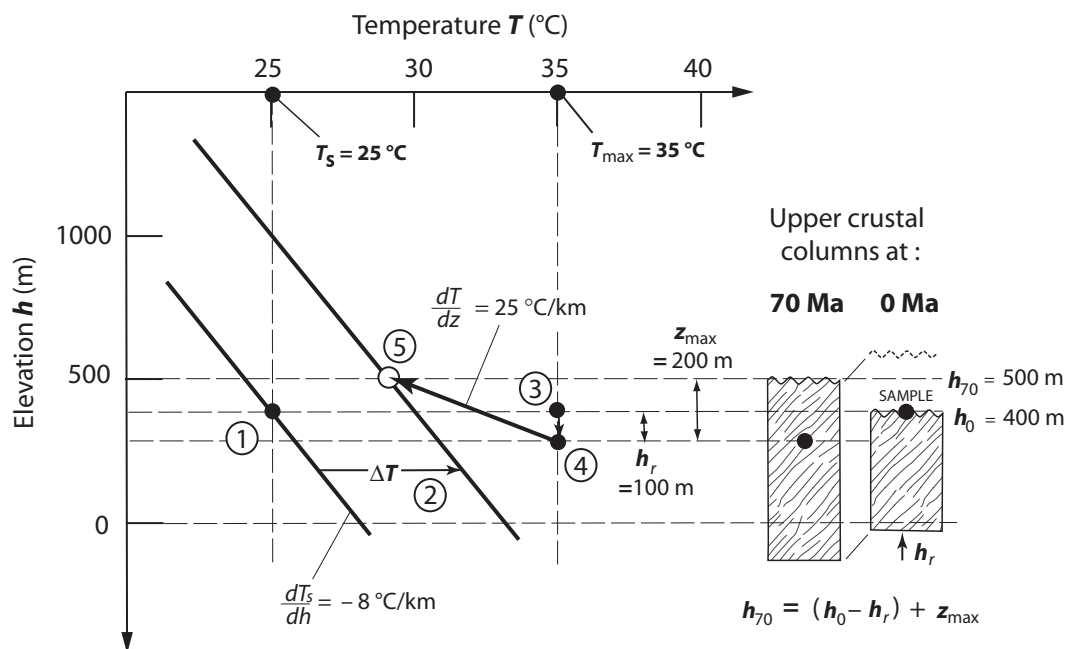

2 m.y., $L = 11$ km. Because the total temperature variation is nearly 300 °C over this depth interval, the perturbation has a much smaller effect on the geothermal gradient than shorter-term, near-surface variations, and acts over a length scale at least an order of magnitude greater than any estimate of z_{\max} . Hence, we approximate the effect of long-term climate change simply as a static shift of the geotherm by ΔT , neglecting its small, positive effect on dT/dz if $\Delta T < 0$, which in any event is at best known to within $\pm 10\%$. This approximation is justified by the fact that high-quality measurements of T_s in shallow boreholes (<200 m) throughout the southwestern United States exhibit systematic variation with elevation (Fig. 11), whereas dT/dz does not (e.g., Sass et al., 1994).

As discussed already, we also neglect the effect of climate change on lapse rate, yielding a Tertiary surface temperature

$$T_s(h) = T_{h=0} - \Delta T + (dT_s/dh)h. \quad (3)$$

The elevation of Earth's surface at the onset of post-70 Ma erosion, h_{70} , is simply

$$h_{70} = (h_0 - h_r) + z_{\max}, \quad (4)$$

where h_r is rock uplift, defined as the net upward displacement of bedrock relative to sea level (Fig. 10). For the small amounts of total erosion under consideration and the relatively narrow aperture of canyon erosion (<20 km), we assume that any isostatic rebound is region-

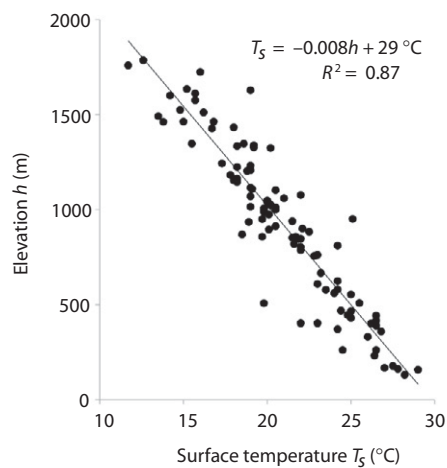

Figure 11. Plot of surface temperature versus elevation in shallow boreholes throughout the southwestern United States. Plot was constructed by extrapolating temperature-depth curves (figs. A2 through A8 in Sass et al., 1994) to Earth's surface. Regression equation assumes h in meters.

ally compensated by the flexurally rigid Colorado Plateau (Lowry and Smith, 1995) and for our purposes is small enough to be neglected, but a number of authors have proposed varying amounts of late Cenozoic rock uplift of the plateau, which is taken into account by Equation 4. For $h = h_{70}$, substituting Equation 4 into Equation 3 yields

$$T_{s\ h70} = T_{h=0} - \Delta T + (dT_s/dh)(h_0 - h_r + z_{\max}). \quad (5)$$

Substituting this expression for $T_{s\ h70}$ into Equation 1 and solving for z_{\max} yields

$$z_{\max} = \frac{[T_{\max} + \Delta T] - [T_{h=0} + \frac{dT_s}{dh}(h_0 - h_r)]}{\frac{dT}{dz} + \frac{dT_s}{dh}}. \quad (6)$$

Equation 6 is a refinement of the customary equation for estimating much larger paleodepths on the basis of thermochronometric data

$$z_{\max} = (T_{\max} - 20\text{ °C})/(dT/dz),$$

where the precise surface temperature, the elevation dependence of surface temperature, rock uplift, and climate change are neglected.

The right-hand side of Equation 6 contains seven parameters, all of which can be estimated on the basis of independent measurements. The greatest uncertainty is contained in the first two terms in the numerator, the sum of the maximum sample temperature and climate change. The remaining four terms in the numerator is simply the present surface temperature of the sample, which is 25 ± 3 °C, neglecting rock uplift (Fig. 10). Regression of the measured surface temperatures from Sass et al. (1994) as a function of elevation (Fig. 11) yields

$$T_s(h) = (29 \pm 2)\text{ °C} + (-8 \pm 1\text{ °C/km})h. \quad (7)$$

The linear fit is surprisingly good ($R^2 = 0.87$) considering that the thermal conductivities and geothermal gradients in the data set both vary by more than a factor of 2, and confirms that MAT is the primary control on shallow surface temperature. As is clear from Equation 6, adding positive rock uplift has the effect of decreasing the estimate of z_{\max} (n.b. that $dT_s/dh < 0$). The denominator is the geothermal gradient minus the absolute value of the surface temperature lapse rate, or $(25 \pm 2\text{ °C/km}) + (-8 \pm 1\text{ °C/km}) = 17 \pm 2\text{ °C/km}$.

The lower extreme for the residence temperature in western Grand Canyon is simply the present surface temperature, or 25 °C, assuming significant lowering of the average elevation of the plateau did not occur (i.e., the case where h_r

is negative). Hence, on the basis of the AHE ages and known surface temperatures, the sample resided between 25 and 35 °C after 70 Ma, with no basis to prefer any particular value within the range. Similarly, there is no preference for any particular value for the decrease in MAT within the 3–8 °C range.

Using these parameters, Equation 6 becomes

$$z_{\max} = [(T_{\max} + \Delta T) - (25 \pm 2\text{ °C})] / (17 \pm 2\text{ °C/km}). \quad (8)$$

The two parameters with standard deviations of $\sim 10\%$ do not introduce large errors into the estimate of z_{\max} , but the sum of $(T_{\max} + \Delta T)$ within the limits for each parameter stated above varies by nearly a factor of 2, ranging from 17 to 32 °C. Using the best estimates of the other two parameters in Equation 8, these limits on $(T_{\max} + \Delta T)$ yield a range of z_{\max} of -470 to $+412$ m. Negative values are, of course, impossible because of the existence of the sample and Earth beneath it, but the upper limit suggests that net erosion since the Cretaceous does not exceed ~ 400 m, a figure less than half the 1000 m maximum erosion implied by the northward projection of the Peach Springs–Truxton paleocanyon discussed previously (Fig. 8, measurement 4), and 200 m less than the 600 m erosion estimated at the beginning of this section on the basis of thermochronology.

The 400 m figure, however, requires a coincidence of extreme values of residence temperature and climate change. The probability of net erosion exceeding a certain value can be estimated using a Monte Carlo approach, assigning equal probability to the occurrence of T_{\max} and ΔT per degree centigrade within their stated ranges. A value of zero net erosion corresponds to $T_{\max} = 28$ °C (but in this case, only the value of $\Delta T = -3$ °C is possible), limiting the total possible range to 28–35 °C, or eight discrete values. For ΔT , there are six discrete values between -3 °C and -8 °C. The multiplication rule yields 48 outcomes with a symmetric distribution, of which 15 combinations result in negative net erosion. The resulting distribution indicates the highest probabilities for $0 < z_{\max} < 235$ m (36/48 cases or 75%), with only 1 of 48 outcomes (2%) yielding the value of 412 m. Taking these outcomes as an approximation for a Gaussian distribution, and ignoring (1) the asymmetry introduced by negative values of z_{\max} and (2) the second and third significant figures, we find an upper limit of $z_{\max} \sim 400$ m at two standard deviations.

By contrast, a depth of $z_{\max} = 1500$ m for most of the post-70 Ma period, assuming $\Delta T = -3$ °C and no rock uplift, yields $T_{\max} > 54$ °C, more than 19 °C too warm, and predicts AHE ages

of less than 20 Ma, at least 40 m.y. too young (Fig. 6). Accounting for the Hualapai Plateau paleocanyons and other data, a relatively modest post-6 Ma erosion of 700 m, coupled with 250 m of rock uplift was proposed by Karlstrom et al. (2008). This case, with $\Delta T = -3$ °C, yields $T_{\max} > 43$ °C, still more than 8 °C too warm, and predicts AHE ages of less than 45 Ma, at least 15 m.y. too young.

A five-step graphical procedure generally applicable to problems of this type allows direct visualization of the relationship between the primary measurements and maximum erosion (Fig. 10). In a space of elevation h versus temperature T , we plot the modern sample elevation h_0 on the modern curve of dT_s/dh (Fig. 10, step 1), and then shift the curve up-temperature by the estimate of the climate change ΔT (step 2). We locate the point (T_{\max} , h_0) (step 3) and shift it downward by the amount of rock uplift h_r (step 4). The maximum burial depth may then be determined by projecting a line with slope of dT/dz upward from the point obtained in step 4 to its intersection with the climate-adjusted curve for $T_s(h)$ obtained in step 2, which yields an estimate for h_{70} , and therefore z_{\max} (step 5). This approach, for $T_{\max} = 35$ °C, mid-range $\Delta T = 5$ °C, and 100 m of rock uplift yields a maximum erosion of 200 m (Fig. 10), which can be analytically verified by using Equation 6. The utility of the plot is that it allows visualization of how uncertainties in dT/dz , dT_s/dh , h_r , T_{\max} , and ΔT affect the estimate of z_{\max} , and in the present case, shows that it is difficult to honor all the constraints with more than a few hundred meters of erosion.

Regardless of the details of these estimates, with only a few hundred meters of erosion, western Grand Canyon landscape in the Diamond Creek area is not dramatically different today than it was at 70 Ma, modified primarily by aggradation of the Rim gravels and overlying strata, and offset as much as a few hundred meters along the Hurricane fault zone. This estimate of erosion is surprising only in that it extends the level of pre-Rim gravel incision, already known from the Hualapai Plateau to be at 1050–1350 m elevation just 8 km south of the canyon, down to a level of between 400 and 800 m elevation within the canyon itself (Fig. 8). Given that the Colorado River in the Diamond Creek area is locally incised as much as 275 m below the basal Cambrian unconformity (Billingsley et al., 1999), the level of erosion through much of Tertiary time would most likely have been near the level of the Tapeats Sandstone or below. This in turn opens up the possibility that a deep, Paleocene–Miocene western Grand Canyon was indeed a potential

source for the orthoquartzite clasts in the Sespe Formation, as originally contemplated (but rejected) by Howard (1996, 2000).

Implications for the Outlet of the Hualapai Plateau Paleocanyons

Pursuant to the Sespe question, the most interesting implication of limiting Cenozoic incision at Diamond Creek to <400 m is that it requires a local base level for the Peach Springs–Truxton paleocanyon at least 300 m, and perhaps as much as 600 m, lower than its projected position at Grand Canyon (measurement 4, Fig. 8), if I have interpreted the error budget for z_{\max} correctly.

Any model that invokes post-6 Ma incision of westernmost Grand Canyon of more than 700–1000 m precludes simply routing the paleocanyon NW down the westernmost segment of Grand Canyon in Paleogene time, because it would require the river to flow uphill between the Diamond Creek area and the Grand Wash Cliffs. Young incision models thus present a sort of “River Styx paradox” for the outlet of the paleocanyon relative to the modern topography towering around it. This paradox led to the suggestion (hypothesis 1, Fig. 8) that the Peach Springs–Truxton paleocanyon escaped northward across the north rim of Grand Canyon toward southern Utah (Young and McKee, 1978; Young, 1979; Elston and Young, 1991). According to this hypothesis, the ancient river need not have had a trajectory that climbed from 1050–1350 m at Diamond Creek to nearly 1900 m immediately to the north, so as to clear the Kaibab escarpment at the southern end of the Shivwits Plateau (Fig. 8). North of Diamond Creek, Grand Canyon runs east of the Shivwits Plateau, in alignment with the northerly trend of the Peach Springs–Truxton paleocanyon (Fig. 2). Thus, the paleocanyon, assuming a base level at Diamond Creek of ~1350 m, could climb northward an additional 350 m to clear the north rim at 1700 m elevation, over a distance of at least 40 km to the north, where the river bends back to the east and the Kaibab escarpment trends E-W (Young, 2001a; Figs. 2 and 8). Hypothesis 1 for the channel’s outlet thus requires extrapolating the SW tilt of the paleocanyon on the Hualapai Plateau northward to affect most of the width of the Coconino terrace (Young, 2001a).

If, however, base level for the paleocanyon at Diamond Creek was at just 600 m elevation, it requires that the paleocanyon, rather than gently rising toward Grand Canyon, instead sloped northward at 3°–4° between extant Rim gravel deposits and the bottom of the canyon (hypothesis 2, Fig. 8). For this hypothesis, the task of surmounting the north rim becomes quite difficult,

because it would require ~2° of tilting of the Coconino terrace (>1100 m in 40 km requires a tilt of 1.6°, plus the northward slope of the channel). Allowing the structurally low channel an outlet through the Grand Wash Trough (hypothesis 2) thus better explains the facts in western Grand Canyon, if not the Muddy Creek problem.

Given these difficulties, it is appropriate to re-examine evidence bearing on whether the paleocanyons lay upstream from the Lower Tertiary fluviolacustrine deposits in Utah, which was an important motivation for the Young-McKee hypothesis. It presumed (1) synchronism of Rim gravel channel aggradation and fluviolacustrine deposition of the Claron Formation and related deposits in southern Utah, and (2) a hydrological connection between the Rim gravels and various gravel bodies north of Grand Canyon (Elston and Young, 1991). As to point 1, whether the Rim gravels are uppermost Eocene instead of lower Eocene, it would be consistent with the hypothesis, within permissible limits on the age of the Claron Formation. An important test as regards point 2 is comparison of the provenance of the Rim gravels with (a) the exposures of “Canaan Peak-type” gravels north of the river, (b) Cretaceous–Paleogene strata exposed in southern Utah, and (c) Paleogene strata in coastal California.

As noted already, the Canaan Peak-type gravels north of the canyon are undated, and therefore could entirely postdate a hypothetical northward paleoslope connecting the Rim gravels with Eocene deposits in southern Utah. Thus, while not precluding the Young-McKee hypothesis, the transport direction and provenance of these gravels, at least as now understood, do little to motivate it.

The source of the Rim gravels, which contain abundant Cenomanian–Maastrichtian volcanic clasts, could also have been a source of Campanian zircons in the pre-Maastrichtian section in southern Utah (e.g., Dickinson and Gehrels, 2008), consistent with the Young-McKee hypothesis. However, the overall pattern of (1) progressively more restricted source regions in the Pine Hollow, (2) the lower Claron’s southward transport direction, and (3) the lack of Cretaceous zircon altogether in the Claron, does not support a connection between the Claron basin and far-traveled detrital input from a Rim gravel source, in either early or late Eocene time. If anything, the data are suggestive of a barrier between any Rim gravel source and southern Utah from Maastrichtian time onward. Thus, as is the case with the Canaan Peak-type gravels, the provenance and paleohydrology of Paleogene sandstone and conglomerate in southern Utah offer little support for a hydrological connection between

highlands SW of Grand Canyon and the plateau in Paleogene time.

In recognition of Goldstrand's (1994) conclusion of western and northern sources for the Claron, Young (2001b) proposed a modification of the Young-McKee hypothesis wherein Rim gravel detritus accumulated in a closed basin in northern Arizona in early Eocene time. This basin may have been physically continuous with the Claron basin, but did not share its northern and western source regions. However, thermochronological data presented previously favoring hypothesis 2 over hypothesis 1 in Figure 8 are difficult to reconcile with the steep northward climb of the drainage system out of the Diamond Creek area of Grand Canyon, as would be required by this model.

The provenance of Paleogene detritus in coastal California, on the other hand, is consistent with a hydrological connection between Rim gravel canyons in the Grand Canyon area and the coastal basins. The absence of Cretaceous arc detritus in the Claron basin and its abundance in both the Rim gravels and coastal basins suggest a convex-north "U"-shaped drainage system where NE-transported Rim gravels south of Grand Canyon were directed into western Grand Canyon and then southward to the coast (Fig. 9B), consistent with hypothesis 2 in Figure 8. The drainage reversal history in the Grand Canyon region would thus contrast with the history of the Rim gravels in the Fort Apache region (Fig. 1), where the drainage system in late Eocene time transported detritus from the Transition Zone ENE onto the plateau in west-central New Mexico (e.g., Potochnik, 2001).

The persistence of Mojave/Mogollon highland detrital input to the Uinta basin along the northern margin of the plateau into early Eocene time (Davis et al., 2010) is difficult to reconcile with this conclusion, because it seemingly requires a hydrological connection between the two regions at a time when data from the Grand Canyon region and southern Utah suggest a reversal in paleoflow direction had already occurred. This paradox is addressed in the context of the paleohydrological model proposed next.

Alternative Hypothesis

To my knowledge, all contemporary hypotheses for the evolution of Grand Canyon, even those that suggest substantial carving of portions of Grand Canyon well before 6 Ma (e.g., Potochnik, 2001; Scarborough, 2001; Flowers et al., 2008; Hill and Ranney, 2008; Young, 2008), do not explicitly challenge some form of piracy or spillover across the Kaibab arch-Coconino terrace region, primarily because of the Muddy Creek problem. If the Paleogene can-

yons of the Hualapai Plateau and western Grand Canyon (and presumably also eastern Grand Canyon, as elaborated in the following) were hydrologically connected to the coast during Paleogene time, how could such a deep, long-lived gorge leave no evidence of its existence in the Muddy Creek Formation or its substrate during Miocene time? Even more enigmatically, why was such a deep gorge carved in Campanian and perhaps early Maastrichtian time? Such an event would presumably have required the combination of a long, first-order trunk stream, coupled with regional, kilometer-scale tectonic uplift (i.e., base-level fall) to drive incision of the enormous canyon.

A Possible Resolution to the Muddy Creek Problem

The problem of the absence of mature fluvial detritus in the Muddy Creek Formation was recently addressed by Young (2008). He proposed that because Grand Wash Trough and basins to the west were occupied by a large lake for much of their existence (Miocene Lake Hualapai of Spencer et al., 2008a), and that the now-dissected lake sediments lie at elevations ranging from 400 to 900 m (up to 500 m above the modern river grade; Fig. 3), an arm of the lake probably extended eastward up through an actively incising western Grand Canyon in Miocene time. Because of this, any river sediment supplied from the integrating drainage system would be trapped in a delta many tens of kilometers upstream, and therefore the only source for coarse detrital deposits in Grand Wash Trough would be local.

The existence of a deep western Grand Canyon throughout Cenozoic time, as suggested here, requires the existence of an even larger Lake Hualapai than envisaged by Young (2008), who depicted the headwaters of the lake in middle to late Miocene time to lie west of the Kaibab arch, cut along escarpments in Upper Paleozoic strata. Even assuming erosion of as much as 400 m in western Grand Canyon and placing it all post-6 Ma, the 900 m elevation of the Hualapai Limestone fill surface in Grand Wash Trough implies that the lake would have been at least 100 m deep at Diamond Creek, and may have backed up as far as eastern Grand Canyon, depending on the details of the late history of erosion and tectonism. However, is such a large hypothetical drainage area compatible with a lack of fluvial detritus in Grand Wash Trough? The same point applies to drainage integration of the upper Colorado River basin during Bidahochi deposition. Assuming modern sediment loads of the upper Colorado River basin are applicable to the Miocene, aggradation rates in the Bidahochi basin are predicted to be

at least an order of magnitude higher than the observed rates (Dallegge et al., 2001).

As also pointed out by Young (2008), modern drainages feeding the Colorado River below Lees Ferry, which constitute 22% of its total drainage area above Lake Mead, contribute only 4% of the total discharge of 500 m³/s. The Little Colorado River drainage, which comprises 19% of the total drainage area upstream from eastern Grand Canyon gauge at Bright Angel Creek, contributes <1% to the total discharge. However, the contributions of these drainages to the sediment load of the Colorado are at present substantial. Construction of Glen Canyon dam near Lees Ferry cut off the sediment load above the dam, such that the postdam drainage, as regards sediment delivery, is similar to the configuration proposed here for Muddy Creek time. The dam reduced the sediment load of the Colorado in Grand Canyon by 83%, from 83,000 to 14,000 Mg/yr (Topping et al., 2000). Thus, even though tributaries to the Colorado below the dam contribute 4% of the discharge, they contributed 17% of the predam sediment load. This raises the question of whether the Grand Wash Trough-Muddy Creek basin could have accommodated the sediment load from a drainage system as large as Grand Canyon and its tributaries below Glen Canyon.

For a closed basin of area A , assuming uniform distribution of sediment, the annual aggradation would be

$$h = m/\rho A,$$

where h is the thickness, m is the mass (annual sediment load), and ρ is the density of the added sediment. For a closed Grand Wash Trough of dimensions 50 km \times 20 km, assuming today's postdam sediment load and sediment density of 2000 kg/m³, it would aggrade at a rate of 7 mm/yr, i.e., two orders of magnitude greater than the observed Miocene rate of ~0.07 mm/yr, and would result in aggradation between 13 and 6 Ma of 49 km of sediment. Even distributing the sediment over the entire area of Lake Hualapai, roughly four times larger than Grand Wash Trough (Spencer et al., 2008a), it would still require an average of >10 km of sediment deposited over a very large area.

Clearly, Grand Canyon could have existed before 6 Ma only if rainfall was insufficient to support streams that carry large sediment loads. Paleobotanical data and climate modeling suggest the region was not only much drier than at present, but also probably lacked intense summer rainfall (Young, 2008, and references therein). Hence, in contrast to the modern system, where vegetation and storminess are optimum to produce large annual sediment loads

in relatively low-discharge streams, arid landscapes with rare intense storms would be expected to have a greatly reduced discharge and sediment flux.

For example, large drainage areas issuing southward from the Oman Mountains (1000–2000 m in elevation) on the northeastern Arabian Peninsula are a typical example of an arid landscape that lacks summer rainfall, and thus may provide a modern analogy for drainage systems in the southwestern United States in Miocene time. Sedimentation on the lowland plains immediately to the south of the range is characterized by meter-scale aggradational events roughly every 100,000 yr since 0.5 Ma (Blechsmidt et al., 2009). Average deposition rates are thus on the order of tens of meters per million years, comparable to the Muddy Creek and Bidahochi Formations, and include very long stretches of time without aggradation. Correlation between these depositional events and precipitation events in caves has been interpreted to reflect infrequent encroachment of monsoonal moisture from the east onto the northern Arabian Peninsula during periods of postglacial warming (Blechsmidt et al., 2009). Winter rainfall in the Oman Mountains is comparable to that of ranges in the southwest United States, indicating that summer storminess is essential for the generation of large annual sediment loads in arid or semiarid drainages. Without periodic encroachment of monsoon moisture, there would have been little or no aggradation on the southern plains since 0.5 Ma. Thus, the existence of the Grand Canyon during Muddy Creek time is precluded by the slow aggradation rate of the Muddy Creek Formation

only if the modern storm-driven sediment loads are applicable to Miocene time.

Even though rainfall patterns may have been insufficient to support sedimentary transport upstream from the Grand Wash Cliffs, there still may have been sufficient rainfall to support groundwater discharge from Grand Canyon to gradually fill and expand Lake Hualapai (e.g., Hunt, 1969). In this scenario, the lake may have accumulated a small amount of both fine sediment and dissolved load from the carbonate uplands (Young, 2008). I suggest that this scenario would be favored by having the entire modern Grand Canyon below Lees Ferry, not yet integrated with its Rocky Mountain sources, draining into Grand Wash Trough and environs, because it would be more effective in promoting the development of large lakes than would the relatively small precursor drainage suggested by Young (2008).

This hypothesis is supported by the fact that deposition of the Hualapai Limestone in the Lake Mead region contrasts strongly with coeval deposits in adjacent basins, in which evaporites predominate over limestone, reflecting a climate that was generally too arid to form permanent lakes (Hunt, 1969). Faulds et al. (2001, p. 87) suggested that “much of the fresh water was probably derived from the western part of the Colorado Plateau through springs issuing from Paleozoic limestone and/or a system of headwardly eroding streams that eventually evolved into the Colorado River.” It is proposed here that the contrast with the surrounding basins instead resulted simply from having Grand Canyon, already formed, as its headwaters, fo-

cusings groundwater discharge that was just sufficient to maintain permanent lakes, which was frustrated by evaporation in the relatively small surrounding drainages. This interpretation obviates the need for either subterranean hydrologic discharge or headward erosion as agents to incise Grand Canyon.

The last element of the Muddy Creek problem to resolve is identifying the course of the river west of Grand Canyon prior to the formation of Grand Wash Trough, where, according to hypothesis 2 (Fig. 8), it must have flowed prior to Muddy Creek deposition. Wheeler Ridge and other tilted fault blocks in the Grand Wash Trough form a continuous belt of exposures of tilted Cambrian through Permian strata that, when palinspastically restored against the Grand Wash Cliffs (Brady et al., 2000), would seemingly lie athwart the western terminus of Grand Canyon. However, previous workers have noted the presence of a paleocanyon in the southern part of Wheeler Ridge near Sandy Point (Figs. 2 and 12A), where there is a 3.5-km-wide gap in exposures of moderately to steeply dipping Paleozoic section and underlying basement rocks (Longwell, 1936; Lucchitta, 1966; Wallace et al., 2005). The canyon fill is gently east-dipping (0° – 10°), very coarse, poorly sorted conglomerate and interstratified rock-avalanche deposits derived from the paleocanyon walls and from Proterozoic basement in the South Virgin Mountains (Fig. 12A). The provenance and high-energy depositional facies indicate generally eastward transport of this detritus from the South Virgin Mountains into the Grand Wash Trough, with

Figure 12. (A) Geologic map of Wheeler Ridge paleocanyon, simplified from Wallace et al. (2005); lines with tick marks and numbers show strike and dip of bedding. (B) Cross section through western Grand Canyon for comparison, using geology from Wenrich et al. (1996). See Figure 2 for location of map and section. Xg—Proterozoic crystalline basement; €—Cambrian strata; DM—Devonian–Mississippian strata; P—Pennsylvanian strata; Tc—Tertiary conglomerate and intercalated ash beds with sandine yielding an Ar–Ar age of 15.3 ± 0.1 Ma; Tm—Muddy Creek Formation (sedimentary rocks of Grand Wash Trough); Th—Hualapai Limestone.

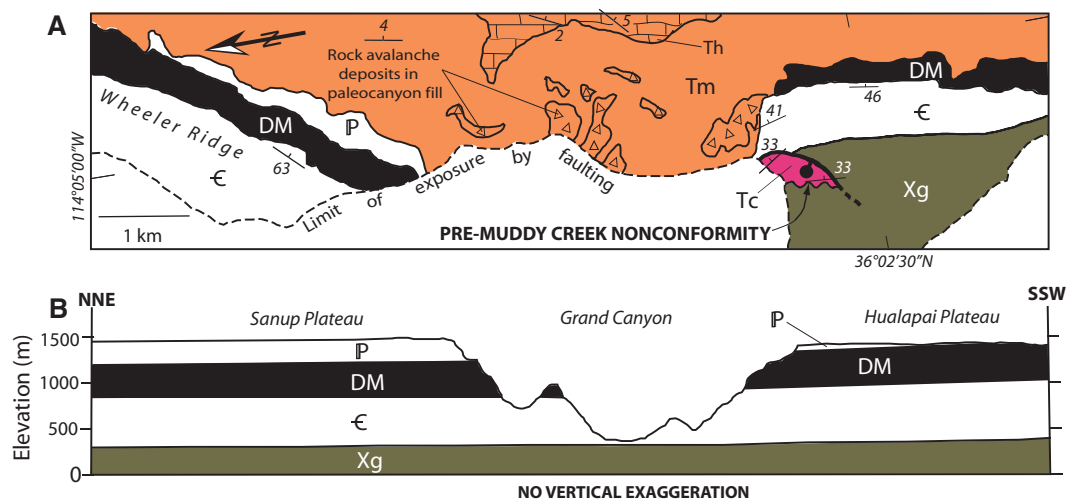

the paleocanyon representing a trunk stream for the distribution of sediment in Grand Wash Trough, mainly by infrequent rock-avalanche and debris-flow events (Lucchitta, 1966, 1979).

Detailed mapping of the paleocanyon walls indicates that it probably had a NE trend as it was being filled, and that the unconformity at the base of the fill overlaps normal faults within the Paleozoic section (Wallace et al., 2005). At the southern end of the paleocanyon, in an isolated fault block just west of the main ridge, a pre-Muddy Creek, Paleozoic-clast conglomerate unit and overlying ash deposits dated at 15.3 ± 0.1 Ma were mapped by Wallace et al. (2005) as resting nonconformably on Proterozoic basement, with two measured dips in the unit both at 33°E (Fig. 12A). Attitudes measured in a transect through the Paleozoic section of the main ridge immediately to the east by Wallace et al. (2005) are (from W to E, going up section) 24° , 41° , 24° , 21° , 41° , 47° , and 73° (mean = 35°), and so, on average, particularly in the Lower Paleozoic units closest to the fault block, the conglomerate appears to have been deposited prior to most of the tilting of the ridge, and is older than the more gently dipping bulk of the canyon fill unit, which to the north contains an ash bed dated at 10.94 ± 0.03 Ma (Wallace et al., 2005).

Wallace et al. (2005) entertained two hypotheses for the origin of the paleocanyon. In the first, it is analogous to one of the Paleogene canyons preserved on the Hualapai Plateau, and was later filled with Neogene rather than Paleogene detritus. In the second, the canyon was not carved until Neogene time, in response to the formation of Grand Wash Trough and the tilting of fault blocks. They preferred the second hypothesis, on the basis that the ancient fill along the canyon wall truncates Miocene normal faults. However, the observation that pre- or early tilt gravel lies unconformably on Proterozoic basement in the vicinity of the canyon favors the existence of a deeply incised canyon prior to extensional tectonism.

I propose that the Wheeler Ridge paleocanyon is a tilted fragment of Grand Canyon. This hypothesis is a composite of the two hypotheses suggested by Wallace et al. (2005), wherein the steep walls of Grand Canyon, originally formed in Late Cretaceous time, were rotated eastward during rifting as a part of the Wheeler Ridge block, except that the canyon had westward paleoflow immediately prior to rifting rather than eastward, and hence was originally downstream from the Peach Springs–Truxton paleocanyon as described previously, rather than a co-tributary draining to the NE.

The erosion surface that truncates normal faults within Wheeler Ridge reflects erosion that occurred late in the history of formation of

Grand Wash Trough, after most faulting and tilting had ceased. However, that erosional event was not necessarily responsible for all, or even a significant fraction of, the erosion that created the paleocanyon. The normal faults truncated by the unconformity have displacements of only a few hundred meters at most, and therefore modest post-tilt erosion would have eliminated any tectonically generated relief prior to aggradation of the fill over the paleocanyon wall, long after most tilting and faulting within Wheeler Ridge had ceased.

The hypothesis that Wheeler Ridge contains a fragment of Grand Canyon is testable using a comparison of a down-plunge view of the Wheeler Ridge paleocanyon (essentially a map view, Fig. 12A) and a vertical north-south cross section of Grand Canyon just upstream from its intersection with the Grand Wash Cliffs (Figs. 2 and 12B). The key question is whether the geometry of the paleocanyon is compatible with the dimensions of western Grand Canyon. The comparison shows that the horizontal N-S separation between any two formations in modern Grand Canyon is about the same as the horizontal separation between the same formations on either side of the Wheeler Ridge paleocanyon, along sections where the modern canyon is most narrow. For example, in both sections, the width of the canyon at the position of the Redwall Limestone is 3–4 km. A deep, pretilt “notch” cut into the top of the future Wheeler Ridge fault block would form a natural topographic depression even after significant rotation of crustal blocks. Therefore, during and after tilting, the ancient channel would likely have been exploited as a local topographic low that focused drainage eastward through the paleocanyon and into the Grand Wash Trough.

Late Cretaceous to Quaternary Paleohydrology of the Colorado River Basin from the Glen Canyon Area to the Coast

The possible resolution of the Muddy Creek problem and consideration of thermochronological, paleoaltimetric, and sedimentary-provenance data suggest a three-phase paleohydrological reconstruction for the southwestern United States, involving two major drainage transitions, one near the Cretaceous-Tertiary boundary and another in the late Miocene (Fig. 13). The transitions define three contrasting drainage networks. Using a convention for naming a river after the state containing its headwaters, I will refer to the first system as the California River and to the second as the Arizona River, the third of course being the modern Colorado River.

California River

The thermochronological, paleoaltimetric, and provenance data suggest that an E-flowing paleocanyon was cut to a depth of 1500 m in Campanian time, to a level near the present erosion surface in western Grand Canyon, and to the level of Lower Mesozoic strata (at river level) in eastern Grand Canyon (Figs. 13A and 13B). Near 20 Ma, prior to the extensional event that formed Grand Wash Trough, the erosion surface in eastern Grand Canyon was lowered to within a few hundred meters of its present position without a major change in relief (Figs. 13D and 13E). Post-20 Ma erosion throughout the canyon has not exceeded a few hundred meters, with perhaps slightly more erosion possible in eastern Grand Canyon (Fig. 4).

The existence of a deep canyon since the Cretaceous raises the questions of why it was cut and which way the river was flowing. Based on provenance data on either side of the orogen, it is clear that the active California arc was feeding large volumes of detritus through a major drainage directly onto the Colorado Plateau, through at least the end of Campanian time (71 Ma). This marked the end of a long period in the Late Cretaceous when the Cordilleran mountain belt was relatively narrow, and the region east of the Sevier belt/miogeoclinal hinge zone (north) or the arc (south) lay near sea level as the Western Interior Seaway withdrew to the east (Fig. 9A; e.g., Dickinson et al., 1988). The carving of the paleocanyon took place during Campanian and



Figure 13. Diagrammatic cross sections of the six areas highlighted in yellow in Figure 9. Wavy lines at the top of each diagram show the elevations of river grades (bottoms of V-shaped depressions, connected by arrows) and surrounding uplands (to the left and right of the depressions), with key formations in depositional basins labeled in italics. Geologic units are Proterozoic crystalline and overlying Proterozoic stratified rocks (brown), Paleozoic strata (light blue), Triassic through Lower Cretaceous strata (forest green), Upper Cretaceous strata (chartreuse), Paleogene strata (gold), Upper Oligocene through mid-Miocene strata (orange), and mid- to late Miocene strata (yellow). Also shown are ophiolitic basement of the forearc terrain (olive green), metamorphosed subduction complex rocks (gray and olive), and Mesozoic arc intrusive rocks (pink). Sediment load in rivers is indicated qualitatively as high (three arrows), moderate (two arrows), and low (one arrow). Horizontal gray lines show elevation above sea level.

Wernicke

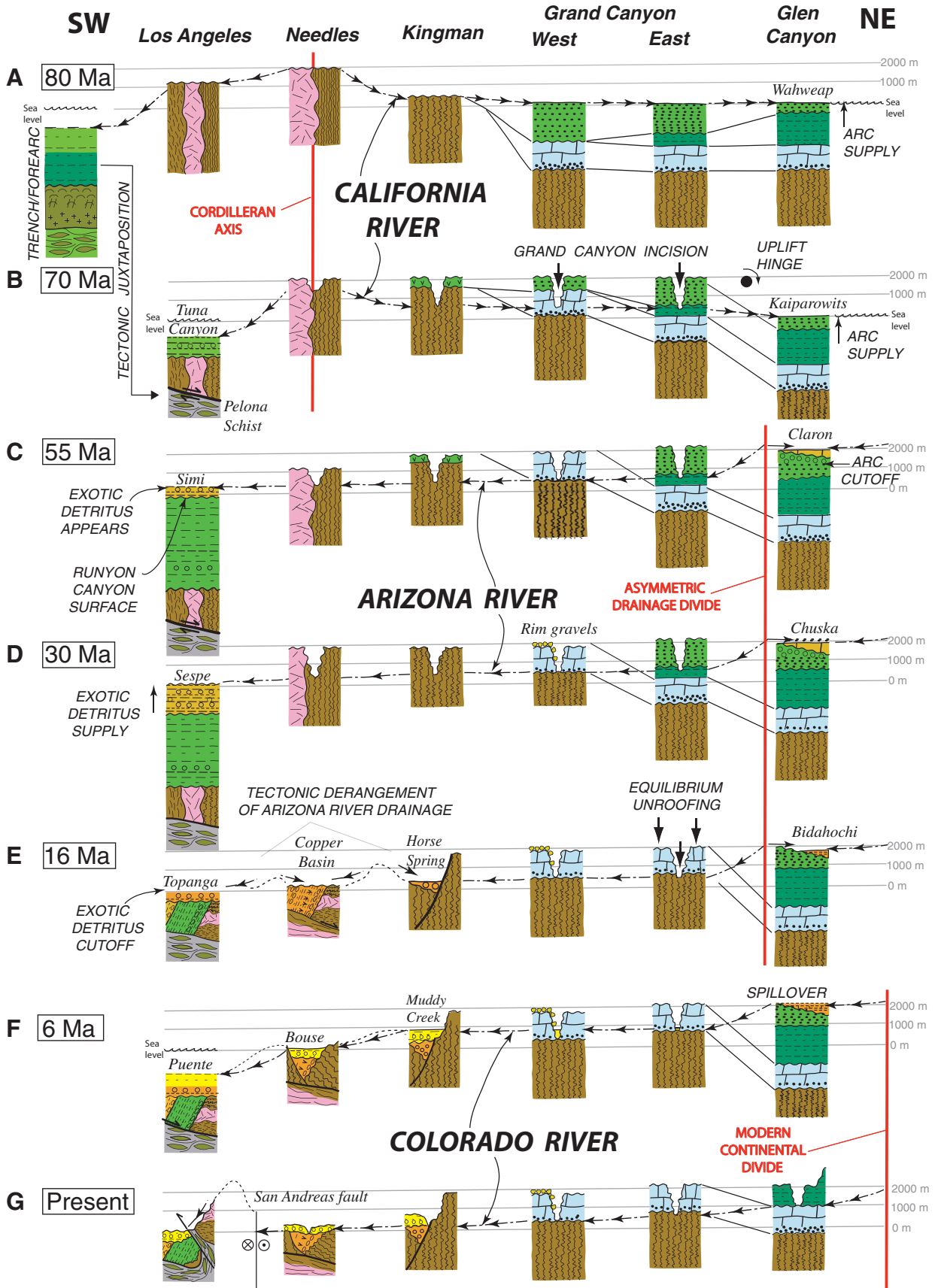

Figure 13.

California River

perhaps the early part of Maastrichtian time (ca. 80–70 Ma, given the uncertainties on the AFT and AHE ages), by a hydrologically important river with extensive headwaters to the SW (Fig. 9A). This period, therefore, marked the beginning of a wave-like expansion of both topographic uplift and erosional unroofing into the Cordilleran foreland (e.g., Flowers et al., 2008; Spencer et al., 2008b), and was coeval with Campanian deformation that disrupted drainage patterns to the east in the Rocky Mountains (Cather, 2004). In the earliest part of the expansion near the beginning of Campanian time, Cordilleran highlands were still focused on the arc, which was an area of active volcanism, high relief, and rapid erosion (Figs. 9A and 13A). By early Maastrichtian time, the expansion resulted in kilometer-scale elevation and relief in the southwestern part of the plateau, while areas to the NE were still low enough to trap sediment eroding from the arc far to the west. The supply of Campanian arc detritus was eventually cut off from the foreland as a result of this process, as recorded in the Canaan Peak Formation, which was still receiving detritus from the eastern Mojave region after incision, but not from the Campanian arc (at a stage intermediate between 70 and 55 Ma; Figs. 13B and 13C). The paleocanyon was thus incised by the California River, and was a major conduit delivering detritus from the topographic crest of the Cordillera in California northeastward to the cratonic foreland.

The paleocanyon had the same approximate depth and position as modern Grand Canyon, if not the precise level of erosion. The term “Grand Canyon,” in current usage, has been restricted by most authors to the modern one, going back to perhaps 6 Ma (e.g., Karlstrom et al., 2008). This usage carries with it the genetic assumption that the canyon is young, having attained its current morphology only over the last 6 m.y. by the coalescence of a system of precursor drainages of markedly different depth and geometry than the modern canyon (e.g., Hill and Ranney, 2008), making it inappropriate to apply the term “Grand Canyon” to any feature older than 6 Ma. In the hypothetical instance that the modern canyon eroded downward an additional kilometer but maintained its modern position and depth, we would still refer to it as Grand Canyon, because a canyon is a topographic feature defined by its morphology, not by its erosion level, age, or relationship to surrounding drainage networks. Therefore, if the hypothesis presented here is correct, then it would be most appropriate to refer to the Cretaceous paleocanyon cut by the California River as “Grand Canyon” (Fig. 13).

Other major conduits clearly existed during this time in central Utah, as demonstrated by

periods of sediment transport transverse (SE) to the Sevier front (Fig. 9A; Lawton et al., 2003), and probably existed farther SE in Arizona, perhaps along an axis parallel to the late Eocene drainage system between the Fort Apache region and the Baca basin (Fig. 9; Potochnik, 2001). AHE cooling ages and stratigraphic data along the Arizona homocline between the Fort Apache region and the transverse drainages in southern Utah do not suggest the presence of any deep Cretaceous canyons other than Grand Canyon (Flowers et al., 2008).

To the NE of the arc from 93 to ca. 75 Ma, the SW margin of the Colorado Plateau was thus a low-relief aggradational plane that lay near sea level, accumulating at least 1500 m of SW-derived sediment (Fig. 13A) that was subsequently stripped away in Campanian through early Eocene time (Fig. 13B; Flowers et al., 2008). Thus, during the Campanian, a NW-trending hinge zone developed between the incising eastern Grand Canyon and aggrading Kaiparowits Plateau region, near the present position of Lees Ferry (Fig. 13B). To the SW of the arc, Maastrichtian basins in coastal California record rapid, proximal deposition of detritus from the eastern arc terrain and its metamorphic framework rocks, in response to tectonic events that formed the continental borderland province (Figs. 9B and 13B).

Arizona River

The cutoff of arc detritus in the southern Utah basins during Maastrichtian time and syntectonic sedimentation during Paleocene–Eocene deposition of the Pine Hollow Formation indicate that the main phase of Laramide deformation in southern Utah is distinctly younger than incision of Grand Canyon, and that it was coeval with major drainage reorganization. A compilation of stratigraphic constraints on the formation of major Laramide uplifts in the Rocky Mountains indicates that after the onset of broad warping in Campanian time (based on the development of centripetal isopach patterns in Cretaceous strata), the main phase of deformation (including steep local relief and stratal rotations) began in late Maastrichtian or Paleocene time (e.g., Dickinson et al., 1988; Cather, 2004). This general history is supported by fission-track studies, which generally yield Maastrichtian and younger (post–70 Ma) AFT ages from samples beneath fossil pre-Laramide PRZs (Kelley and Chapin, 2004), although some older ages (up to 74 Ma) may reflect cooling during Campanian unroofing (Cather, 2004).

At a position along orogenic strike corresponding to Grand Canyon (transect highlighted in yellow in Fig. 9 and depicted in Fig. 13), a key observation is the appearance of detritus

composite of Mojave/Mogollon highlands provenance along the coast in Paleocene time (e.g., Simi Conglomerate at >56 Ma) coeval with its disappearance from deposits in southern Utah (Paleocene–Eocene Pine Hollow Formation). Hence, at least in this region, depocenters on both sides of the orogen indicate expansion of the coastal drainage networks and contraction of the interior networks (Figs. 9B and 13C). Drainage of the interior toward the coast also affected portions of southern and eastern Arizona in early Tertiary time (e.g., Kies and Abbott, 1983; Howard, 2000). Farther north in central Nevada, studies of Paleogene drainage patterns suggest a topographic divide near longitude 116°W (Henry, 2008; Fig. 9B).

The observation that the Paleogene Colton Formation contains a similar arc-dominated detrital zircon signature as the Campanian Kaiparowits Formation (ultimately originating in the Mojave/Mogollon highlands) is seemingly in conflict with the Maastrichtian cutoff of arc-derived material in southern Utah, and with “hypothesis 2” in Figure 8, which implies that the drainage reversal in Grand Canyon had already occurred by early Eocene time. If the California River persisted into early Eocene time (Davis et al., 2010), it would have to have been hydrologically isolated from the Claron basin. Alternatively, the Colton Formation may have been sourced in more proximal Laramide uplands that were cut in Kaiparowits-equivalent strata (e.g., along the flanks of the Monument upwarp, Fig. 9B).

Assuming that the cutoff of arc detritus in southern Utah signals the timing of drainage reversal and that “hypothesis 2” is correct, I infer that during early Tertiary time, the interior Laramide basins were separated from steep, SW-draining headwaters in the Grand Canyon region by an asymmetric, NW-trending drainage divide located in what is now the Lee Ferry–Glen Canyon area (Figs. 9B, 13C, 13D, and 13E). The primary motivation for the position and asymmetry of the divide is to provide a mechanism for subsequent drainage integration.

The geomorphology of this divide, if not the precise tectonic setting, is envisaged to be similar to the divide along the headwaters of the La Paz River in South America, a component of the retroarc Amazon River drainage basin. The La Paz River near the city of La Paz, Bolivia, is unusual in comparison to most rivers that drain the eastern side of the Andes in that it is eroding headward into the Altiplano (Fig. 14). In contrast, other drainages along orogenic strike have headwaters in the much higher topography along the east flank of the Eastern Cordillera. The steep gradient of the La Paz River contrasts with the gentle backslope of the top of the plateau toward



Figure 14. GoogleEarth™ image looking NW over the city of La Paz, Bolivia, onto the Altiplano toward Lake Titicaca. Headward erosion of the La Paz River drainage has created an asymmetrical drainage divide with steep SW slopes draining to the Atlantic Ocean and gentle NW slopes that lie within 200 m of the level of Lake Titicaca.

lakes Titicaca and Poopo to the west. These lakes are part of a closed drainage system of interconnected lakes lying on a low-relief surface near 4000 m elevation, underlain by a thick Tertiary basin fill that wedges out at roughly the position of the drainage divide (e.g., Zeilinger and Schlunegger, 2007). From this configuration, overtopping the divide would require very little adjustment of the landscape (the divide is only 200 m higher than Lake Titicaca), but it would have the extraordinary consequence of diverting a huge, long-lived upland drainage area away from the closed lake basins and into the Atlantic Ocean. As elaborated in the following, a similar scenario may apply to the late Miocene integration that formed the Colorado River.

On the basis of this geomorphological analogy, eastern Grand Canyon and its tributaries would have formed amphitheater-like headwaters cut into Mesozoic strata SW of the divide (Fig. 9B), which from 55 to 20 Ma was rimmed by Upper Cretaceous strata near 2000 m elevation and floored with Triassic near 500 m elevation (Figs. 13C, 13D, and 13E). To avoid significant input of 0.4–1.3 Ga zircons from plateau erg deposits into the Sespe (Spafford et al., 2009), I infer that the Mesozoic erg deposits were omitted across the sub-Cretaceous unconformity in eastern Grand Canyon region, such that mid-Cretaceous strata lay disconformably on the Triassic Chinle Formation. Prior to ca. 20 Ma, the Paleozoic erg deposits (Coconino Sandstone) would have remained in the sub-

surface. By 16 Ma, at the onset of aggradation of the Bidahochi Formation NE of the divide, the amphitheater lay at about the same elevation as it was in early to mid-Tertiary time, but was instead rimmed by Permian strata and floored by Cambrian Tapeats Sandstone and underlying Proterozoic sedimentary and crystalline rocks, not greatly above its present erosion level (Figs. 13D and 13E; Flowers et al., 2008). Between 16 and 20 Ma, the Coconino Sandstone would have been exposed to erosion, but would have constituted only a small fraction (<10%) of the total eroded volume from the eastern Grand Canyon area, which underlay only a small fraction (<10%) of the total area draining into the Sespe basin. Given that ~30% of the zircons in the Coconino are younger than 1.3 Ga (Dickinson and Gehrels, 2003), it is difficult to envisage their contribution to Sespe zircon population as being more than ~0.3%.

Because thermochronologic evidence suggests that western Grand Canyon was likely cut to a level near the Tapeats Sandstone by the California River, drainage reversal could well have supplied abundant, highly survivable Tapeats gravels from Grand Canyon to the coast beginning in Paleocene time, including the “lavender, pink, and purple quartz arenite clasts” present in the basal Simi Conglomerate of Paleocene age (Colburn and Novak, 1989) and Eocene conglomerates of the Sespe Formation (Howard, 1996). I envisage a system wherein a main trunk stream generally transverse to the axis of Cordilleran uplift

originated in eastern Grand Canyon and was fed by Howard’s (2000) orogen-parallel Gila- and Amargosa-Colorado paleorivers (Fig. 9B). The existence of an Amargosa-Colorado paleoriver is supported by episodes of fluvial aggradation from early Oligocene through middle Miocene time documented in the Death Valley–Amargosa Desert region, Titus Canyon, Panuga, and Eagle Mountain Formations, which consistently exhibit southeasterly to southerly transport (Reynolds, 1969; Snow and Lux, 1999; Niemi et al., 2001; Renik et al., 2008).

The model illustrated in Figures 9 and 13 is broadly similar to earlier models for the Cretaceous–Paleogene evolution of Grand Canyon, based on an analogy between Grand Canyon and the evolution of the Fort Apache region. These models include the elements of partial incision of Grand Canyon during the Laramide orogeny by NE-flowing rivers, followed by post-Laramide drainage reversal that reused the older canyons (e.g., Potochnik, 2001; Scarborough, 2001; Young, 2001b). The primary differences between these models for Grand Canyon and the present interpretation are that (1) Grand Canyon incision occurred prior to the main stage of Laramide deformation in the region, (2) drainage reversal was Maastrichtian–Paleocene rather than mid-Tertiary, and (3) the early Tertiary drainage was hydrologically connected to the Pacific Ocean rather than the interior.

It should also be emphasized that placement of the drainage divide near Lees Ferry in Paleogene time, as opposed to a position farther SW in the eastern Mojave Desert, is not required by the coastal provenance data. Rather, the primary motivations for this facet of the model are that it (1) terminates the high-relief, southern sediment supply (Mojave/Mogollon highlands) to the interior basins in southern Utah, replacing it with an asymmetric divide (Figs. 13B and 13C); (2) places a high-relief, future spillover point near the geographic center of the plateau (Figs. 9B and 13F); and (3) maintains a consistent flow direction within Grand Canyon at any given time, rather than having to place a drainage divide within an already deep canyon, positioned somewhere between Diamond Creek and the Upper Granite Gorge (Figs. 13B–13G).

Tectonic Derangement of the Lower Arizona River Drainage

Between 25 and 16 Ma, the Mogollon Highlands, which lay between the Gila and upper Arizona rivers for most of Tertiary time (Fig. 9B), foundered due to crustal extension, allowing much of the NE-directed drainage previously flowing toward Grand Canyon (Rim gravels) to be captured and to flow south-westward (Mayer, 1979; Peirce et al., 1979;

Potochnik, 2001; Young, 2001b, 2008). This event resulted in ~1500 m of unroofing in a 75-km-wide band along the NE flank of the Arizona homocline, including the eastern Grand Canyon region and portions of the future Bidahochi basin region to the SE (Flowers et al., 2008). This event also corresponded to a transition from an aggradational regime on the plateau to one in which aggraded materials were largely removed, with the informative exceptions of the Rim gravels (capped with early Miocene volcanics) and Chuska erg deposits (e.g., Elston and Young, 1991; Cather et al., 2008).

By 17 Ma, extension in the Basin and Range Province had propagated northward to begin forming Grand Wash Trough. Owing to extension, by 13 Ma, successions in the coastal delta system, eastern Mojave, and Grand Wash Trough had all developed pronounced angular unconformities (time between Figs. 13E and 13F; e.g., Davis, 1988; Dibblee, 1989; Wallace et al., 2005). Also by this time, rapid tectonism deranged the Arizona River and its tributaries below western Grand Canyon into a system of local basins, including the coastal region (Fig. 14E; Ingersoll and Rumelhart, 1999). This event left only Grand Canyon as the headwaters to Grand Wash Trough and Lake Hualapai, and marked the end of the supply of exotic Arizona River detritus to the coastal basins (e.g., Dibblee, 1989). This period also marked the onset of middle and upper Miocene aggradational events high on the Colorado Plateau as recorded by the Bidahochi Formation, in Grand Wash Trough as recorded by the Muddy Creek Formation, and along the coast as recorded by the Puente and equivalent formations (Fig. 14F).

Colorado River

The interior of the plateau north of Grand Canyon thus far has yielded much younger cooling ages than the SW margin of the plateau (e.g., Stöckli, 2005; Flowers et al., 2008), suggesting that major denudation, primarily of weakly resistant Mesozoic strata, has occurred since 10 Ma (Pederson et al., 2002a). After 6 Ma, under increasingly wet conditions in the Rocky Mountains (e.g., Chapin, 2008), aggradation in the Bidahochi basin became sufficient to overtop the asymmetrical divide in the Lees Ferry–Glen Canyon area (Fig. 13F), an event analogous to a hypothetical future overtopping of the asymmetric divide between the Altiplano and La Paz River drainages. This hypothesis is similar to that of Scarborough (2001), except that it places the spillover point somewhat farther north than eastern Grand Canyon, to account for pre-Bidahochi cooling of the Upper Granite Gorge to near-surface temperatures (Flowers et al., 2008). This event integrated the upper Arizona River

drainage with what is now the upper Colorado River drainage. The sudden increase in discharge and sediment load may have been as much as two orders of magnitude, forcing a rapid cascade of spillover events that completed the integration of the modern Colorado River drainage (e.g., Meek and Douglass, 2001; Scarborough, 2001; Spencer and Pearthree, 2001; House et al., 2008; Douglass et al., 2009).

One strength of this interpretation is that prior to 6 Ma, the upper Colorado River drainage basin was either closed or drained out through the northern plateau and the Pacific Northwest (e.g., Spencer et al., 2008b), eliminating the problem of finding a pre-6 Ma outlet (e.g., Meek and Douglass, 2001). A second strength is that Grand Canyon was already in existence at the time of spillover (e.g., Scarborough, 2001), eliminating the “precocious gully” problem of Hunt (1968, 1969). Any hypothetical river that would overtop the Kaibab arch or take advantage of a relatively shallow precursor canyon cut through it is still confronted with another 160 km of resistant, high plateau to the west to carve through before arriving at the Grand Wash Cliffs, with little hydrological impetus to either incise Grand Canyon or begin excavation of the plateau interior. A high spillover point in the Lees Ferry–Glen Canyon area would be accompanied by rapid knickpoint migration and kilometer-scale incision in order to establish the present river grade, which is over 1000 m below the highest Bidahochi deposits to the east. The profound lowering of base level at a position well within the plateau interior (as opposed to along its margin at Grand Wash Cliffs) would explain the thorough evacuation of any relatively thin lacustrine deposits that may have accumulated during Muddy Creek time in Grand Canyon (e.g., Meek and Douglass, 2001). In summary, this interpretation relieves the long-standing twin headaches of searching for the outlet of the pre-Grand Canyon Colorado River (e.g., Pederson, 2008)—no such entity ever existed—and searching for a mechanism to incise the Kaibab arch–Coconino terrace region in late Cenozoic time (e.g., Karlstrom et al., 2008)—Grand Canyon was already there. In so doing, it also suggests that the Colorado River did not play a significant role in excavating Grand Canyon.

CONCLUSIONS

Perhaps the primary implication of this interpretive synthesis is that it reinforces the counterintuitive conclusion that Grand Canyon is a long-lived equilibrium landscape of the general type envisaged by Hack (1960), having maintained its position and approximate depth,

if not its precise dimensions, through kilometer-scale of unroofing over tens of millions of years (Flowers et al., 2008). To first order, its form appears to be independent of the amount of postincision unroofing, which is, at most, a few hundred meters in western Grand Canyon but ~1500 m in eastern Grand Canyon. Its basic form also appears to have survived a shift from predominantly humid, wet conditions at the time of incision to more arid conditions in Oligocene and Miocene time (e.g., Gregory and Chase, 1994; Young, 1999). These aspects of the system contrast with Hack’s (1960) premise that tectonic and climatic forcing would, in general, result in adjustment of the landscape to the new conditions. Any such adjustments are at present beyond the resolution of the thermochronological data summarized in Figure 4.

The history proposed here is not consistent with recent incision models based on extrapolation of late Quaternary incision rates of 60–190 m/m.y. back to 6 Ma, which are sufficient to carve most of Grand Canyon (>1100 m in eastern Grand Canyon) since that time (e.g., Pederson et al., 2002b; Karlstrom et al., 2007, 2008). The total incision recorded by these measurements is <100 m, covering a time period of 500–700 k.y. If both the incision rates and the thermochronological data are honored, this suggests that the relatively wet glacial climates over the last 2 m.y. have had a significant effect on the late Cenozoic incision rate. For western Grand Canyon, 130 m of incision could be accommodated at an average rate of 65 m/m.y. since 2 Ma, with rates averaging an order of magnitude less before that time. Similarly, erosion of 380 m in eastern Grand Canyon since 2 Ma is consistent with the AHE and AFT data. However, substantially more post-20 Ma erosion would require significantly different Cenozoic thermal histories for the sample suites in the canyon and on the rim, contrary to the thermochronological data. During Muddy Creek/Bidahochi time (13–6 Ma) or Rim gravel/Chuska time (50–25 Ma), the canyon itself may have been aggrading (e.g., Scarborough, 2001; Young, 2001b). Thus, even with major unroofing near 20 Ma, modification of its topographic form since 70 Ma appears to have been relatively modest.

From an historical perspective, referring to the Green, San Juan, and Colorado Rivers upstream of Grand Wash Trough, Powell (1875, p. 198) rather forcefully concluded:

Though the entire region has been folded and faulted on a grand scale, these displacements have never determined the course of the streams. All the facts ... lead to the inevitable conclusion that the system of drainage was determined antecedent to the faulting, and folding, and erosion, which are observed, and antecedent, also, to the eruptive beds and cones.

If the interpretation summarized in Figure 13 is correct, then Grand Canyon was clearly cut by an antecedent stream according to the definition of Powell (1875). However, if the Bidahochi basin overtopped an asymmetrical drainage divide, then prior to 6 Ma, any rivers upstream from Grand Canyon were likely meandering on a high, low-relief plane (analogous to the meandering Desaguadero River in Bolivia that connects Lake Titicaca and Lake Poopo), atop various post-Laramide deposits; therefore, they would be considered superposed rather than antecedent (e.g., Hunt, 1969). Inversion of the Colorado, Green, and San Juan Rivers by sudden base-level drop near Lees Ferry and their rapid adjustment to grade would have promoted the development of the entrenched meanders of textbook fame that characterize all three rivers (e.g., Longwell, 1946; Scarborough, 2001). Although Powell (1875) and other early workers did not envisage early Tertiary drainage reversal, the present synthesis is, nonetheless, consonant with Powell's fundamental insight that a drainage divide across the Kaibab arch never existed.

ACKNOWLEDGMENTS

The late Don Elston first introduced me to the concept of a Cretaceous age for Grand Canyon. I am also grateful to J.M. Eiler, K.A. Farley, R.M. Flowers, K.W. Huntington, J.B. Saleeby, and R.A. Young for discussions that prompted this synthesis, and to S.J. Davis, W.R. Dickinson, M. Grove, R.V. Ingersoll, and J.E. Spencer for sharing detrital zircon data prior to publication. I thank K.A. Farley and J. Harvey for assistance with the RDAAM model and using the HeFTy software. The presentation was greatly improved from the careful and constructive reviews of S.M. Cather, R.V. Ingersoll, K.E. Karlstrom, P.K. Link, J. Pederson, J.D. Walker, and R.A. Young, although responsibility for errors in either fact or interpretation rest solely with the author. Figure 13 was drafted by J. Mayne. This research was funded by National Science Foundation grant EAR-0810324 and the Gordon and Betty Moore Foundation (Tectonics Observatory Cont. #143).

REFERENCES CITED

- Atwater, T., and Stock, J., 1998, Pacific-North America plate tectonics of the Neogene southwestern United States: An update: *International Geology Review*, v. 40, p. 375–402, doi: 10.1080/00206819809465216.
- Beard, L.S., 1993, Tertiary stratigraphy of the South Virgin Mountains, southeast Nevada and the Grand Wash Trough, northwest Arizona, in Sherrod, D.R., and Nielson, J.E., eds., *Tertiary Stratigraphy of Highly Extended Terranes, California, Arizona and Nevada*: U.S. Geological Survey Bulletin 2053, p. 29–32.
- Bernet, M., 2009, A field-based estimate of the zircon fission-track closure temperature: *Chemical Geology*, v. 259, p. 181–189, doi: 10.1016/j.chemgeo.2008.10.043.
- Billingsley, G.H., Hawkins, D., Huntoon, P.W., Ilg, B.R., Sears, J.H., and Williams, M.L., 1996, *Geologic Map of the Eastern Part of the Grand Canyon National Park: Grand Canyon, Arizona, Grand Canyon, Grand Canyon Association, scale 1:65,500, 1 sheet.*
- Billingsley, G.H., Wenrich, K.J., Huntoon, P.W., and Young, R.A., 1999, *Breccia-Pipe and Geologic Map of the Southwestern Part of the Hualapai Indian Reservation and Vicinity, Arizona*: U.S. Geological Survey Map I-2554, scale 1:48,000, 1 sheet.
- Billingsley, G.H., Beard, L.S., Priest, S.S., Wellmeyer, J.L., and Block, D.L., 2004, *Geologic Map of Lower Grand Wash Cliffs and Vicinity, Mohave County, Northwest Arizona*: U.S. Geological Survey Map MF-2427, scale 1:31,680, 1 sheet.
- Blackwelder, E., 1934, *Origin of the Colorado River*: Geological Society of America Bulletin, v. 45, p. 551–565.
- Blechschildt, I., Matter, A., Preusser, F., and Rieke-Zapp, D., 2009, Monsoon triggered formation of Quaternary alluvial megafans in the interior of Oman: *Geomorphology*, v. 110, p. 128–139, doi: 10.1016/j.geomorph.2009.04.002.
- Bohannon, R.G., 1984, *Nonmarine Sedimentary Rocks of Tertiary Age in the Lake Mead Region, Southeastern Nevada and Northwestern Arizona*: U.S. Geological Survey Professional Paper 1259, 72 p.
- Brady, R., Wernicke, B., and Fryxell, J., 2000, Kinematic evolution of a large-offset continental normal fault system, South Virgin Mountain, Nevada: *Geological Society of America Bulletin*, v. 112, p. 1375–1397, doi: 10.1130/0016-7606(2000)112<1375:KEOALO>2.0.CO;2.
- Burbank, D.W., Beck, R.A., Reynolds, R.G.H., Hobbs, R., and Tahirkheli, R.A.K., 1988, Thrusting and gravel progradation in foreland basins—A test of post-thrusting gravel dispersal: *Geology*, v. 16, p. 1143–1146, doi: 10.1130/0091-7613(1988)016<1143:TAGPIF>2.3.CO;2.
- Carlslaw, H.S., and Jaeger, J.C., 1959, *Conduction of Heat in Solids*: Oxford, UK, Clarendon, 510 p.
- Cather, S.M., 2004, Laramide orogeny in central and northern New Mexico and southern Colorado, in Mack, G.H., and Giles, K.A., eds., *The Geology of New Mexico, A Geologic History: New Mexico Geological Society Special Publication 11*, p. 203–248.
- Cather, S.M., Connell, S.D., Chamberlin, R.M., McIntosh, W.C., Jones, G.E., Potochnik, A.R., Lucas, S.G., and Johnson, P.S., 2008, The Chuska erg: Paleogeomorphic and paleoclimatic implications of an Oligocene sand sea on the Colorado Plateau: *Geological Society of America Bulletin*, v. 120, p. 13–33.
- Chapin, C.E., 2008, Interplay of oceanographic and paleoclimate events with tectonism during middle to late Miocene sedimentation across the southwestern USA: *Geosphere*, v. 4, p. 976–991, doi: 10.1130/GES00171.1.
- Chipping, D.H., 1972, Early Tertiary paleogeography of central California: *American Association of Petroleum Geologists Bulletin*, v. 56, p. 480–493.
- Chisholm, T.J., and Chapman, D.S., 1992, Climate change inferred from analysis of borehole temperatures—An example from western Utah: *Journal of Geophysical Research—Solid Earth*, v. 97, p. 14,155–14,175, doi: 10.1029/92JB00765.
- Colburn, I.P., and Novak, G.A., 1989, Paleocene conglomerates of the Santa Monica Mountains, California: Petrology, stratigraphy, and environments of deposition, in Colburn, I.P., Abbott, P.L., and Minch, J., eds., *Conglomerates in Basin Analysis: A Symposium Dedicated to A.O. Woodford*: Bakersfield, California, Pacific Section, Society of Economic Paleontologists and Mineralogists, p. 227–253.
- Crittelli, S., Rumelhart, P.E., and Ingersoll, R.V., 1995, Petrofacies and provenance of the Puente Formation (Middle to Upper Miocene), Los Angeles Basin, Southern California—Implications for rapid uplift and accumulation rates: *Journal of Sedimentary Research, ser. A, Sedimentary Petrology and Processes*, v. 65, p. 656–667.
- Crow, R., Karlstrom, K.E., McIntosh, W., Peters, L., and Dunbar, N., 2008, History of Quaternary volcanism and lava dams in western Grand Canyon based on Lidar analysis, Ar-40/Ar-39 dating, and field studies: Implications for flow stratigraphy, timing of volcanic events, and lava dams: *Geosphere*, v. 4, p. 183–206, doi: 10.1130/GES00133.1.
- Dallegge, T.A., Ort, M.H., McIntosh, W.C., and Perkins, M.E., 2001, Age and depositional basin morphology of the Bidahochi Formation and implications for the ancestral upper Colorado River, in Young, R.A., and Spamer, E.E., eds., *Colorado River Origin and Evolution: Grand Canyon, Arizona, Grand Canyon Association*, p. 47–51.
- Davis, G.A., 1988, Rapid upward transport of mid-crustal mylonitic gneisses in the footwall of a Miocene detachment fault, Whipple Mountains, southeastern California: *Geologische Rundschau*, v. 77, p. 191–209, doi: 10.1007/BF01848684.
- Davis, S.J., Dickinson, W.R., Gehrels, G.E., Spencer, J.E., Lawton, T.F., and Carroll, A.R., 2010, The Paleogene California River: Evidence of Mojave-Uinta paleodrainage from U-Pb ages of detrital zircons: *Geology*, v. 38, p. 931–934, doi: 10.1130/G31250.1.
- Davis, W.M., 1899, *The geographical cycle: The Geographical Journal*, v. 14, p. 481–504, doi: 10.2307/1774538.
- DeCelles, P.G., 2004, Late Jurassic to Eocene evolution of the Cordilleran thrust belt and foreland basin system, western USA: *American Journal of Science*, v. 304, p. 105–168, doi: 10.2475/ajs.304.2.105.
- Dibblee, T.W., 1989, Miocene conglomerates and breccias in the northeastern Ventura Basin and northern Los Angeles Basin and their tectonic significance, in Colburn, I.P., Abbott, P.L., and Minch, J., eds., *Conglomerates in Basin Analysis: A Symposium Dedicated to A.O. Woodford*: Bakersfield, California, Pacific Section, Society of Economic Paleontologists and Mineralogists, p. 207–226.
- Dickinson, W.R., 1981, Plate tectonics and the continental margin of California, in Ernst, W.G., ed., *The Geotectonic Development of California, Rubey Volume I: Englewood Cliffs, New Jersey, Prentice-Hall*, p. 1–28.
- Dickinson, W.R., 1983, Cretaceous sinistral strike slip along Nacimiento fault in coastal California: *The American Association of Petroleum Geologists Bulletin*, v. 67, p. 624–645.
- Dickinson, W.R., and Gehrels, G.E., 2003, U-Pb ages of detrital zircons from Permian and Jurassic eolian sandstones of the Colorado Plateau, USA: Paleogeographic implications: *Sedimentary Geology*, v. 163, p. 29–66, doi: 10.1016/S0037-0738(03)00158-1.
- Dickinson, W.R., and Gehrels, G.E., 2008, Sediment delivery to the Cordilleran foreland basin: Insights from U-Pb ages of detrital zircons in Upper Jurassic and Cretaceous strata of the Colorado Plateau: *American Journal of Science*, v. 308, p. 1041–1082.
- Dickinson, W.R., and Gehrels, G.E., 2009, U-Pb ages of detrital zircons in Jurassic eolian and associated sandstones of the Colorado Plateau: Evidence for transcontinental dispersal and intraregional recycling of sediment: *Geological Society of America Bulletin*, v. 121, p. 408–433.
- Dickinson, W.R., Klute, M.A., Hayes, M.J., Janecke, S.U., Lundin, E.R., Mckittrick, M.A., and Olivares, M.D., 1988, Paleogeographic and paleotectonic setting of Laramide sedimentary basins in the central Rocky Mountain region: *Geological Society of America Bulletin*, v. 100, p. 1023–1039, doi: 10.1130/0016-7606(1988)100<1023:PAPSOL>2.3.CO;2.
- Dickinson, W.R., Duca, M., Rosenberg, L.I., Greene, H.G., Graham, S.A., Clark, J.C., Weber, G.E., Kidder, S., Ernst, W.G., and Brabb, E.E., 2005, Net Dextral Slip, Neogene San Gregorio-Hosgri Fault Zone, Coastal California: *Geologic Evidence and Tectonic Implications*: Geological Society of America Special Paper 391, 43 p.
- Dorsey, R.J., Fluette, A., McDougall, K., Housen, B.A., Janecke, S.U., Axen, G.J., and Shirvell, C.R., 2007, Chronology of Miocene-Pliocene deposits at Split Mountain Gorge, Southern California: A record of regional tectonics and Colorado River evolution: *Geology*, v. 35, p. 57–60, doi: 10.1130/G23139A.1.
- Douglass, J., Meek, N., Dorn, R.I., and Schmeeckle, M.W., 2009, A criteria-based methodology for determining the mechanism of transverse drainage development, with application to the southwestern United States: *Geological Society of America Bulletin*, v. 121, p. 586–598.
- Dumitru, T.A., Duddy, I.R., and Green, P.F., 1994, Mesozoic-Cenozoic burial, uplift, and erosion history of the west-central Colorado Plateau: *Geology*, v. 22, p. 499–502, doi: 10.1130/0091-7613(1994)022<0499:MCBUAE>2.3.CO;2.
- Dutton, C.E., 1882, *Tertiary History of the Grand Cañon District*: Reston, Virginia, U.S. Geological Survey, 92 p.

California River

- Eiler, J.M., 2007, "Clumped-isotope" geochemistry—The study of naturally-occurring, multiply-substituted isotopologues: Earth and Planetary Science Letters, v. 262, p. 309–327, doi: 10.1016/j.epsl.2007.08.020.
- Elston, D.P., and Young, R.A., 1991, Cretaceous-Eocene (Laramide) landscape development and Oligocene-Pliocene drainage reorganization of transition zone and Colorado Plateau, Arizona: *Journal of Geophysical Research—Solid Earth and Planets*, v. 96, p. 12,389–12,406, doi: 10.1029/90JB01978.
- Elston, D.P., Young, R.A., McKee, E.H., and Dennis, M.L., 1989, Paleontology, clast ages and paleomagnetism of Upper Paleocene and Eocene gravel and limestone deposits, Colorado Plateau and transition zone, northern and central Arizona, in Elston, D.P., Billingsley, G.H., and Young, R.A., eds., *Geology of Grand Canyon, Northern Arizona (with Colorado River Guides)*: Washington, D.C., American Geophysical Union, p. 155–165.
- Emmons, S.F., 1897, The origin of the Green River: *Science*, v. 6, p. 19–21, doi: 10.1126/science.6.131.19.
- Farley, K.A., 2000, Helium diffusion from apatite: General behavior as illustrated by Durango fluorapatite: *Journal of Geophysical Research*, v. 105, p. 2903–2914, doi: 10.1029/1999JB900348.
- Faulds, J.E., Wallace, M.A., Gonzales, L.A., and Heizler, M.T., 2001, Depositional environment and paleogeographic implications of the late Miocene Hualapai Limestone, northwestern Arizona, in Young, R.A., and Spamer, E.E., eds., *Colorado River Origin and Evolution: Grand Canyon, Arizona*, Grand Canyon Association, p. 81–88.
- Finnell, T.L., 1966, Geologic Map of the Cibique Quadrangle, Navajo County, Arizona: U.S. Geological Survey Map GQ-545, Geological Quadrangle Series, scale 1:62,500, 1 sheet.
- Fitzgerald, P.G., Fryxell, J.E. and Wernicke, B.P., 1991, Miocene crustal extension and uplift in southeastern Nevada—Constraints from fission-track analysis: *Geology*, v. 19, p. 1013–1016.
- Fitzgerald, P.G., Duebendorfer, E.M., Faulds, J.E., and O'Sullivan, P., 2009, South Virgin–White Hills detachment fault system of SE Nevada and NW Arizona: Applying apatite fission track thermochronology to constrain the tectonic evolution of a major continental detachment fault: *Tectonics*, v. 28, p. TC2001, doi: 10.1029/2007TC002194.
- Flowers, R.M., Shuster, D.L., Wernicke, B.P., and Farley, K.A., 2007, Radiation damage control on apatite (U-Th)/He dates from the Grand Canyon region, Colorado Plateau: *Geology*, v. 35, p. 447–450, doi: 10.1130/G23471A.1.
- Flowers, R.M., Wernicke, B.P., and Farley, K.A., 2008, Unroofing, incision, and uplift history of the southwestern Colorado Plateau from apatite (U-Th)/He thermochronometry: *Geological Society of America Bulletin*, v. 120, p. 571–587, doi: 10.1130/B26231.1.
- Flowers, R.M., Ketcham, R.A., Shuster, D.L., and Farley, K.A., 2009, Apatite (U-Th)/He thermochronometry using a radiation damage accumulation and annealing model: *Geochimica et Cosmochimica Acta*, v. 73, p. 2347–2365, doi: 10.1016/j.gca.2009.01.015.
- Foster, D.A., Gleadow, A.J.W., Reynolds, S.J., and Fitzgerald, P.G., 1993, Denudation of metamorphic core complexes and the reconstruction of the transition zone, west central Arizona—Constraints from apatite fission-track thermochronology: *Journal of Geophysical Research—Solid Earth*, v. 98, p. 2167–2185, doi: 10.1029/92JB02407.
- Ghosh, P., Garzzone, C.N., and Eiler, J.M., 2006, Rapid uplift of the Altiplano revealed through C-13–O-18 bonds in paleosol carbonates: *Science*, v. 311, p. 511–515, doi: 10.1126/science.1119365.
- Goldstrand, P.M., 1990, Stratigraphy and Paleogeography of Late Cretaceous and Paleogene Rocks of Southwest Utah: Utah Geological and Mineralogical Survey Miscellaneous Publication 90–2, 58 p.
- Goldstrand, P.M., 1992, Evolution of Late Cretaceous and Early Tertiary basins of southwest Utah based on clastic petrology: *Journal of Sedimentary Petrology*, v. 62, p. 495–507.
- Goldstrand, P.M., 1994, Tectonic development of Upper Cretaceous to Eocene strata of southwestern Utah: *Geological Society of America Bulletin*, v. 106, p. 145–154, doi: 10.1130/0016-7606(1994)106<0145:TDOUCT>2.3.CO;2.
- Green, P.F., 1988, The relationship between track shortening and fission-track age reduction in apatite—Combined influences of inherent instability, annealing anisotropy, length bias and system calibration: *Earth and Planetary Science Letters*, v. 89, p. 335–352, doi: 10.1016/0012-821X(88)90121-5.
- Gregory, K.M., and Chase, C.G., 1994, Tectonic and climatic significance of a late Eocene low-relief, high-level geomorphic surface, Colorado: *Journal of Geophysical Research—Solid Earth*, v. 99, p. 20,141–20,160, doi: 10.1029/94JB00132.
- Grove, K., 1989, Upper Cretaceous conglomerates from the Salinian terrane, west-central California, in Colburn, I.P., Abbott, P.L., and Minch, J., eds., *Conglomerates in Basin Analysis: A Symposium Dedicated to A.O. Woodford*: Bakersfield, California, Pacific Section, Society of Economic Paleontologists and Mineralogists, p. 143–160.
- Grove, K., 1993, Latest Cretaceous basin formation within the Salinian terrane of west-central California: *Geological Society of America Bulletin*, v. 105, p. 447–463, doi: 10.1130/0016-7606(1993)105<0447:LCBFWT>2.3.CO;2.
- Hack, J.T., 1960, Interpretation of erosional topography in humid temperate regions: *American Journal of Science*, v. 258–A, p. 80–97.
- Heimsath, A.M., Dietrich, W.E., Nishiizumi, K., and Finkel, R.C., 1999, Cosmogenic nuclides, topography, and the spatial variation of soil depth: *Geomorphology*, v. 27, p. 151–172, doi: 10.1016/S0169-555X(98)00095-6.
- Henry, C.D., 2008, Ash-flow tuffs and paleovalleys in northeastern Nevada: Implications for Eocene paleogeography and extension in the Sevier hinterland, northern Great Basin: *Geosphere*, v. 4, p. 1–35, doi: 10.1130/GES00122.1.
- Hill, C.A., and Ranney, W.D., 2008, A proposed Laramide proto-Grand Canyon: *Geomorphology*, v. 102, p. 482–495, doi: 10.1016/j.geomorph.2008.05.039.
- Hill, C.A., Eberz, N., and Buecher, R.H., 2008, A karst connection model for Grand Canyon, Arizona, USA: *Geomorphology*, v. 95, p. 316–334, doi: 10.1016/j.geomorph.2007.06.009.
- Holm, R.F., 2001, Cenozoic paleogeography of the central Mogollon Rim—southern Colorado Plateau region, Arizona, revealed by Tertiary gravel deposits, Oligocene to Pleistocene lava flows, and incised streams: *Geological Society of America Bulletin*, v. 113, p. 1467–1485, doi: 10.1130/0016-7606(2001)113<1467:CPOTCM>2.0.CO;2.
- House, M.A., Wernicke, B.P., and Farley, K.A., 1998, Dating topography of the Sierra Nevada, California, using apatite (U-Th)/He ages: *Nature*, v. 396, p. 66–69, doi: 10.1038/23926.
- House, M.A., Wernicke, B.P., and Farley, K.A., 2001, Paleo-geomorphology of the Sierra Nevada, California, from (U-Th)/He ages in apatite: *American Journal of Science*, v. 301, p. 77–102, doi: 10.2475/ajs.301.2.77.
- House, P.K., Pearthree, P.A., and Perkins, M.E., 2008, Stratigraphic evidence for the role of lake spillover in the incision of the lower Colorado River in southern Nevada and western Arizona, in Reheis, M.C., Hershler, R., and Miller, D.M., eds., *Late Cenozoic Drainage History of the Southwestern Great Basin and Lower Colorado River Basin: Geologic and Biotic Perspectives*: Geological Society of America Special Paper 439, p. 335–353.
- Howard, J.L., 1996, Paleocene to Holocene paleodeltas of ancestral Colorado River offset by the San Andreas fault system, southern California: *Geology*, v. 24, p. 783–786, doi: 10.1130/0091-7613(1996)024<0783:PTHPOA>2.3.CO;2.
- Howard, J.L., 2000, Provenance of quartzite clasts in the Eocene-Oligocene Sespe Formation: Paleogeographic implications for southern California and the ancestral Colorado River: *Geological Society of America Bulletin*, v. 112, p. 1635–1649, doi: 10.1130/0016-7606(2000)112<1635:POQCIT>2.0.CO;2.
- Howard, K.A., and Bohannon, R.G., 2001, Lower Colorado River: Upper Cenozoic deposits, incision and evolution, in Young, R.A., and Spamer, E.E., eds., *Colorado River Origin and Evolution: Grand Canyon, Arizona*, Grand Canyon Association, p. 101–106.
- Howard, K.A., Lundstrom, S.C., Malmson, D.V., and Hook, S.J., 2008, Age distribution and formation of late Cenozoic paleovalleys of the lower Colorado River and their relation to river aggradation and degradation, in Reheis, M.C., Hershler, R., and Miller, D.M., eds., *Late Cenozoic Drainage History of the Southwestern Great Basin and Lower Colorado River Basin: Geologic and Biotic Perspectives*: Geological Society of America Special Paper 439, p. 391–410.
- Hunt, C.B., 1968, Review of "Evolution of the Colorado River in Arizona," in McKee, E.D., Wilson, R.F., Breed, W.J., and Breed, C.S., eds.: *Geotimes*, v. 13, no. 2, p. 39.
- Hunt, C.B., 1969, Geologic history of the Colorado River: The Colorado River region and John Wesley Powell: U.S. Geological Survey Professional Paper 669C, p. 59–130.
- Huntington, K.W., Wernicke, B.P., and Eiler, J.M., 2010, The influence of climate change and uplift on Colorado Plateau paleotemperatures from carbonate 'clumped isotope' thermometry: *Tectonics*, v. 29, doi: 10.1029/2009TC002449.
- Ingersoll, R.V., 1982, Initiation and evolution of the Great Valley forearc basin of northern and central California, in Leggett, J.K., ed., *Trench-Forearc Geology: Sedimentation and Tectonics on Modern and Ancient Active Plate Margins*: Geological Society of London Special Publication 10, p. 459–467.
- Ingersoll, R.V., 1998, Phanerozoic tectonic evolution of central California and environs, in Ernst, W.G., and Nelson, C.A., eds., *Integrated Earth and Environmental Evolution of the Southwestern United States*: Columbia, Maryland, Bellwether, p. 349–364.
- Ingersoll, R.V., and Rumelhart, P.E., 1999, Three-stage evolution of the Los Angeles basin, southern California: *Geology*, v. 27, p. 593–596, doi: 10.1130/0091-7613(1999)027<0593:TSEOTL>2.3.CO;2.
- Jacobson, C.E., Grove, M., Pedrick, J.N., Barth, A.P., Marsaglia, K.M., Gehrels, G.E., and Nourse, J.A., 2010, Late Cretaceous–early Cenozoic tectonic evolution of the southern California margin inferred from provenance of trench and forearc sediments: *Geological Society of America Bulletin*, doi: 10.1130/B30238.
- Jinnah, Z.A., Roberts, E.M., Deino, A.L., Larsen, J.S., Link, P.K., and Fanning, C.M., 2009, New Ar-40–Ar-39 and detrital zircon U-Pb ages for the Upper Cretaceous Wahweap and Kaiparowits Formations on the Kaiparowits Plateau, Utah: Implications for regional correlation, provenance, and biostratigraphy: *Cretaceous Research*, v. 30, p. 287–299, doi: 10.1016/j.cretres.2008.07.012.
- Karlstrom, K.E., Crow, R.S., Peters, L., McIntosh, W., Raucci, J., Crossey, L.J., Umhoefer, P., and Dunbar, N., 2007, Ar-40/Ar-39 and field studies of Quaternary basalts in Grand Canyon and model for carving Grand Canyon: Quantifying the interaction of river incision and normal faulting across the western edge of the Colorado Plateau: *Geological Society of America Bulletin*, v. 119, p. 1283–1312, doi: 10.1130/0016-7606(2007)119[1283:AAFQQ]2.0.CO;2.
- Karlstrom, K.E., Crow, R., Crossey, L.J., Coblenz, D., and Van Wijk, J.W., 2008, Model for tectonically driven incision of the younger than 6 Ma Grand Canyon: *Geology*, v. 36, p. 835–838, doi: 10.1130/G25032A.1.
- Kelley, S.A., and Chapin, C.E., 2004, Denudation history and internal structure of the Front Range and Wet Mountains, Colorado, based on apatite-fission-track thermochronology, in Cather, S.M., McIntosh, W.C., and Kelley, S.A., eds., *Tectonics, Geochronology and Volcanism in the Southern Rocky Mountains and Rio Grande Rift*: Socorro, New Mexico, New Mexico Bureau of Geology and Mineral Resources Bulletin 160, p. 41–78.
- Kelley, S.A., Chapin, C.E., and Karlstrom, K.E., 2001, Laramide cooling histories of Grand Canyon, Arizona, and the Front Range, Colorado, determined from apatite fission-track thermochronology, in Young, R.A., and Spamer, E.E., eds., *Colorado River Origin and Evolution: Grand Canyon, Arizona*, Grand Canyon Association, p. 37–42.

- Ketcham, R.A., Donelick, R.A., and Carlson, W.D., 1999, Variability of apatite fission-track annealing kinetics: III. Extrapolation to geological time scales: *The American Mineralogist*, v. 84, p. 1235–1255.
- Kies, R.P., and Abbott, P.L., 1983, Rhyolite clast populations and tectonics in the California continental borderland: *Journal of Sedimentary Petrology*, v. 53, p. 461–476.
- Kimbrough, D., Grove, M., Gehrels, G., Dorsey, R., House, K.P., Howard, K., Pearthree, P.A., Spencer, J.E., and Mahoney, B., 2007, Detrital zircon record of Colorado River incision: *Eos (Transactions, American Geophysical Union)*, v. 88, no. T41, p. C–03.
- Lachenbruch, A.H., and Sass, J.H., 1978, Models of an extending lithosphere and heat flow in the Basin and Range Province, in Smith, R.B., and Eaton, G.P., eds., *Cenozoic Tectonics and Regional Geophysics of the Western Cordillera*: Geological Society of America Memoir 152, p. 209–250.
- Larsen, J.S., 2007, *Facies and Provenance of the Pine Hollow Formation: Implications for the Sevier Foreland Basin Evolution and the Paleocene Climate of Southern Utah* [M.S. thesis]: Pocatello, Idaho State University, 119 p.
- Larsen, J.S., Link, P.K., Roberts, E.M., Tapanila, L., and Fanning, C.M., 2010, Cyclic stratigraphy of the Paleogene Pine Hollow Formation and detrital zircon provenance of Campanian to Eocene sandstones of the northwestern Kaiparowits Basin, south-central Utah: *Utah Geological Association Field Trip Guidebook* (in press).
- Laslett, G.M., Green, P.F., Duddy, I.R., and Gleadow, A.J.W., 1986, Thermal annealing of fission tracks in apatite: 2. A quantitative analysis: *Chemical Geology*, v. 65, p. 1–13.
- Lawton, T.F., Pollock, S.L., and Robinson, R.A.J., 2003, Integrating sandstone petrology and nonmarine sequence stratigraphy: Application to the Late Cretaceous fluvial systems of southwestern Utah: *Journal of Sedimentary Research*, v. 73, p. 389–406, doi: 10.1306/100702730389.
- Link, P.K., Roberts, E., Fanning, C.M., and Larsen, J.S., 2007, Detrital zircon age populations from Upper Cretaceous and Paleogene Wahweap, Kaiparowits, Canaan Peak, Pine Hollow and Claron Formations, Kaiparowits Plateau, southern Utah: *Geological Society of America Abstracts with Programs*, v. 39, no. 5, p. 7.
- Longwell, C.R., 1936, Geology of the Boulder Reservoir floor, Arizona-Nevada: *Geological Society of America Bulletin*, v. 47, p. 1393–1476.
- Longwell, C.R., 1946, How old is the Colorado River: *American Journal of Science*, v. 244, p. 817–835.
- Lowry, A.R., and Smith, R.B., 1995, Strength and rheology of the western US Cordillera: *Journal of Geophysical Research-Solid Earth*, v. 100, p. 17,949–17,963.
- Lucchitta, I., 1966, Cenozoic Geology of the Lake Mead Area Adjacent to the Grand Wash Cliffs, Arizona [Ph.D. thesis]: State College, Pennsylvania State University, 218 p.
- Lucchitta, I., 1972, Early history of Colorado River and Basin and Range Province: *Geological Society of America Bulletin*, v. 83, p. 1933–1948, doi: 10.1130/0016-7606(1972)83[1933:EHOTCR]2.0.CO;2.
- Lucchitta, I., 1979, Late Cenozoic uplift of the southwestern Colorado Plateau and adjacent lower Colorado River region: *Tectonophysics*, v. 61, p. 63–95, doi: 10.1016/0040-1951(79)90292-0.
- Lucchitta, I., 1984, Development of landscape in northwest Arizona: The country of plateaus and canyons, in Smiley, T.L., Nations, J.D., Péwé, T.L., and Schafer, J.P., eds., *Landscapes of Arizona, the Geologic Story*: Lanham, Maryland, University Press of America, p. 269–302.
- Lucchitta, I., 2003, *History of the Grand Canyon and the Colorado River*, in Beus, S.S., and Morales, M., eds., *Grand Canyon Geology*: New York, Oxford University Press, p. 260–274.
- Lucchitta, I., and Jeanne, R.A., 2001, Geomorphic features and processes of the Shivwits Plateau, Arizona, and their constraints on the age of western Grand Canyon, in Young, R.A., and Spamer, E.E., eds., *Colorado River Origin and Evolution*: Grand Canyon, Arizona, Grand Canyon Association, p. 65–69.
- Martin, M.W., and Walker, J.D., 1992, Extending the western North American Proterozoic and Paleozoic craton through the Mojave Desert: *Geology*, v. 20, p. 753–756, doi: 10.1130/0091-7613(1992)020<0753:ETWNP>2.3.CO;2.
- Mayer, L., 1979, Evolution of the Mogollon Rim in central Arizona: *Tectonophysics*, v. 61, p. 49–62, doi: 10.1016/0040-1951(79)90291-9.
- McKee, E.D., Wilson, R.F., Breed, W.J., and Breed, C.S., 1967, Evolution of the Colorado River in Arizona: Flagstaff, Arizona, Museum of Northern Arizona Bulletin 44, 67 p.
- McQuarrie, N., and Wernicke, B.P., 2005, An animated tectonic reconstruction of southwestern North America since 36 Ma: *Geosphere*, v. 1, p. 147–172, doi: 10.1130/GES00016.1.
- Meek, N., and Douglass, J., 2001, Lake overflow: An alternative hypothesis for Grand Canyon incision and development of the Colorado River, in Young, R.A., and Spamer, E.E., eds., *Colorado River Origin and Evolution*: Grand Canyon, Arizona, Grand Canyon Association, p. 199–204.
- Naeser, C.W., Duddy, I.R., Elston, D.P., Dumitru, T.A., and Green, P.F., 1989, Fission-track dating: Ages for Cambrian strata, and Laramide and post-middle Eocene cooling events from the Grand Canyon, Arizona, in Elston, D.P., Billingsley, G.H., and Young, R.A., eds., *Geology of Grand Canyon, Northern Arizona (with Colorado River Guides)*: Washington, D.C., American Geophysical Union, p. 139–144.
- Niemi, N.A., Wernicke, B.P., Brady, R.J., Saleeby, J.B., and Dunne, G.C., 2001, Distribution and provenance of the middle Miocene Eagle Mountain Formation, and implications for regional kinematic analysis of the Basin and Range Province: *Geological Society of America Bulletin*, v. 113, p. 419–442, doi: 10.1130/0016-7606(2001)113<0419:DAPOTM>2.0.CO;2.
- Page, B.M., 1981, The southern Coast Ranges, in Ernst, W.G., ed., *The Geotectonic Development of California*, Rubey Volume I: Englewood Cliffs, New Jersey, Prentice-Hall, p. 329–417.
- Pearthree, P.A., Spencer, J.E., Faulds, J.E., and House, P.K., 2008, Comment on “Age and evolution of the Grand Canyon revealed by U-Pb dating of water table-type speleothems”: *Science*, v. 321, p. 1634c, doi: 10.1126/science.1158862.
- Pederson, J., 2008, The mystery of the pre-Grand Canyon Colorado River—Results from the Muddy Creek Formation: *GSA Today*, v. 18, p. 4–10, doi: 10.1130/GSAT01803A.1.
- Pederson, J., Mackley, R.D., and Eddleman, J.L., 2002a, Colorado Plateau uplift and erosion evaluated using GIS: *GSA Today*, v. 12, p. 4–10, doi: 10.1130/1052-5173(2002)012<0004:CPUAEE>2.0.CO;2.
- Pederson, J., Karlstrom, K.E., McIntosh, W.C., and Sharp, W., 2002b, Geomorphic implications of new absolute ages and associated incision and fault-slip rates in Grand Canyon: *Geology*, v. 30, p. 739–742, doi: 10.1130/0091-7613(2002)030<0739:DIOTGC>2.0.CO;2.
- Pederson, J., Young, R., Lucchitta, I., Beard, L.S., and Billingsley, G., 2008, Comment on “Age and evolution of the Grand Canyon revealed by U-Pb dating of water table-type speleothems”: *Science*, v. 321, p. 1634b, doi: 10.1126/science.1158019.
- Pierce, H.W., Damon, P.E., and Shafiqullah, M., 1979, An Oligocene (?) Colorado Plateau edge in Arizona: *Tectonophysics*, v. 61, p. 1–24, doi: 10.1016/0040-1951(79)90289-0.
- Polyak, V., Hill, C., and Asmerom, Y., 2008a, Age and evolution of the Grand Canyon revealed by U-Pb dating of water table-type speleothems: *Science*, v. 319, p. 1377–1380, doi: 10.1126/science.1151248.
- Polyak, V., Hill, C., and Asmerom, Y., 2008b, Response to comments on the “Age and evolution of the Grand Canyon revealed by U-Pb dating of water table-type speleothems”: *Science*, v. 321, p. 1634d, doi: 10.1126/science.1159762.
- Potochnik, A.R., 2001, Paleogeomorphic evolution of the Salt River region: Implications for Cretaceous-Laramide inheritance for ancestral Colorado River drainage, in Young, R.A., and Spamer, E.E., eds., *Colorado River Origin and Evolution*: Grand Canyon, Arizona, Grand Canyon Association, p. 17–22.
- Potochnik, A.R., and Faulds, J.E., 1998, A tale of two rivers: Mid-Tertiary structural inversion and drainage reversal across the southern boundary of the Colorado Plateau, in Duebendorfer, E.M., ed., *Geologic Excursions in Northern and Central Arizona*, Field Trip Guidebook: Flagstaff, Arizona, Geological Society of America, Rocky Mountain Section, p. 149–174.
- Powell, J.L., 2005, *Grand Canyon, Solving Earth's Grandest Puzzle*: New York, Pearson Education, Inc., 308 p.
- Powell, J.W., 1875, *Exploration of the Colorado River of the West and Its Tributaries*: Washington, D.C., U.S. Government Printing Office, 291 p.
- Quigley, M., Karlstrom, K., Kelley, S., and Heizler, M., 2010, Timing and mechanisms of basement uplift and exhumation in the Colorado Plateau–Basin and Range Transition Zone, Virgin Mountain anticline, Nevada-Arizona, in Umhoefer, P.J., Beard, L.S., and Lamb, M.A., eds., *Miocene Tectonics of the Lake Mead Region, Central Basin and Range*: Geological Society of America Special Paper 463, p. 311–329, doi: 10.1130/2010.2463(14).
- Reiners, P.W., and Shuster, D.L., 2009, Thermochronology and landscape evolution: *Physics Today*, v. 62, p. 31–36, doi: 10.1063/1.3226750.
- Reiners, P.W., Brady, R., Farley, K.A., Fryxell, J.E., Wernicke, B.P., and Lux, D., 2000, Helium and argon thermochronometry of the Gold Butte block, South Virgin Mountains, Nevada: *Earth and Planetary Science Letters*, v. 178, p. 315–326, doi: 10.1016/S0012-821X(00)00080-7.
- Renik, B., Christie-Blick, N., Troxel, B.W., Wright, L.A., and Niemi, N.A., 2008, Re-evaluation of the middle Miocene Eagle Mountain Formation and its significance as a piercing point for the interpretation of extreme extension across the Death Valley region, California, USA: *Journal of Sedimentary Research*, v. 78, p. 199–219, doi: 10.2110/jsr.2008.022.
- Reynolds, M.W., 1969, *Stratigraphy and Structural Geology of the Titus and Titanotheria Canyons Area, Death Valley, California* [Ph.D. thesis]: Berkeley, University of California, 310 p.
- Sahagian, D., Proussevitch, A., and Carlson, W., 2003, Timing of Colorado Plateau uplift: Initial constraints from vesicular basalt-derived paleoelevations: *Geology*, v. 31, p. 807–810, doi: 10.1130/0091-7613(2003)031<0807:2.0.CO;2.
- Saleeby, J., 2003, Segmentation of the Laramide slab—Evidence from the southern Sierra Nevada region: *Geological Society of America Bulletin*, v. 115, p. 655–668, doi: 10.1130/0016-7606(2003)115<0655:SOTLSF>2.0.CO;2.
- Sass, J.H., Lachenbruch, A.H., Galanis, S.P., Morgan, P., Priest, S.S., Moses, T.H., and Munroe, R.J., 1994, Thermal regime of the southern Basin and Range Province: 1. Heat-flow data from Arizona and the Mojave Desert of California and Nevada: *Journal of Geophysical Research—Solid Earth*, v. 99, p. 22,093–22,119, doi: 10.1029/94JB01891.
- Scarborough, R., 2001, Neogene development of the Little Colorado River Valley and eastern Grand Canyon: Field evidence for an overtopping hypothesis, in Young, R.A., and Spamer, E.E., eds., *Colorado River Origin and Evolution*: Grand Canyon, Arizona, Grand Canyon Association, p. 207–212.
- Shuster, D.L., and Farley, K.A., 2004, He-4/He-3 thermochronometry: *Earth and Planetary Science Letters*, v. 217, p. 1–17, doi: 10.1016/S0012-821X(03)00595-8.
- Shuster, D.L., Flowers, R.M., and Farley, K.A., 2006, The influence of natural radiation damage on helium diffusion kinetics in apatite: *Earth and Planetary Science Letters*, v. 249, p. 148–161, doi: 10.1016/j.epsl.2006.07.028.
- Snow, J.K., and Lux, D.R., 1999, Tectono-sequence stratigraphy of Tertiary rocks in the Cottonwood Mountains and northern Death Valley area, California and Nevada, in Wright, L.A., and Troxel, B.W., eds., *Cenozoic Basins of the Death Valley Region*: Geological Society of America Special Paper 333, p. 17–64.
- Spafford, C.D., Ingersoll, R.V., and Grove, M., 2009, Detrital zircons and sandstone petrofacies of the Sespe

California River

- Formation, southern California: Ventura, California, Pacific Section Meeting, May 3–5, 2009, American Association of Petroleum Geologists, Pacific Section Meeting, Search and Discovery article 90088.
- Spencer, J.E., and Pearthree, P.A., 2001, Headward erosion versus closed-basin spillover as alternative causes of Neogene capture of the ancestral Colorado River by the Gulf of California, *in* Young, R.A., and Spamer, E.E., eds., *Colorado River Origin and Evolution: Grand Canyon, Arizona*, Grand Canyon Association, p. 215–222.
- Spencer, J.E., Pearthree, P.A., and House, P.K., 2008a, An evaluation of the evolution of the latest Miocene to earliest Pliocene Bouse Lake system in the lower Colorado River valley, southwestern USA, *in* Reheis, M.C., Hershler, R., and Miller, D.M., eds., *Late Cenozoic Drainage History of the Southwestern Great Basin and Lower Colorado River Basin: Geologic and Biotic Perspectives: Geological Society of America Special Paper 439*, p. 375–390, doi: 10.1130/2008.2439(17).
- Spencer, J.E., Smith, G.R., and Dowling, T.E., 2008b, Middle to late Cenozoic geology, hydrography and fish evolution in the American Southwest, *in* Reheis, M.C., Hershler, R., and Miller, D.M., eds., *Late Cenozoic Drainage History of the Southwestern Great Basin and Lower Colorado River Basin: Geologic and Biotic Perspectives: Geological Society of America Special Paper 439*, p. 279–299.
- Spencer, J.E., Richard, S.M., Gehrels, G.E., Gleason, J.D., and Dickinson, W.R., 2011, Age and tectonic setting of the Mesozoic McCoy Mountains Formation in western Arizona, USA: *Geological Society of America Bulletin* (in press).
- Spiegel, C., Kohn, B., Raza, A., Rainer, T., and Gleadow, A., 2007, The effect of long-term low-temperature exposure on apatite fission track stability: A natural annealing experiment in the deep ocean: *Geochimica et Cosmochimica Acta*, v. 71, p. 4512–4537, doi: 10.1016/j.gca.2007.06.060.
- Stewart, J.H., Gehrels, G.E., Barth, A.P., Christie-Blick, N., and Wrucke, C.T., 2001, Detrital zircon provenance of Mesoproterozoic to Cambrian arenites in the western United States and northwestern Mexico: *Geological Society of America Bulletin*, v. 113, p. 1343–1356, doi: 10.1130/0016-7606(2001)113<1343:DZPOMT>2.0.CO;2.
- Stöckli, D.F., 2005, Thermochronometric constraints on Tertiary erosional exhumation and incision of the Colorado Plateau—A progress report: *Geological Society of America Abstracts with Programs*, v. 37, no. 7, p. 109.
- Stüwe, K., White, L., and Brown, R., 1994, The influence of eroding topography on steady-state isotherms—Application to fission-track analysis: *Earth and Planetary Science Letters*, v. 124, p. 63–74, doi: 10.1016/0012-821X(94)00068-9.
- Topping, D.J., Rubin, D.M., and Vierra, L.E., 2000, Colorado River sediment transport: 1. Natural sediment supply limitation and the influence of Glen Canyon Dam: *Water Resources Research*, v. 36, p. 515–542, doi: 10.1029/1999WR900285.
- Turcotte, D.L., and Schubert, G., 1982, *Geodynamics*: New York, John Wiley and Sons, 450 p.
- Walcott, C.D., 1890, Study of a line of displacement in the Grand Canyon of the Colorado: *Geological Society of America Bulletin*, v. 1, p. 49–64.
- Wallace, M.A., Faulds, J.E., and Brady, R.J., 2005, *Geologic Map of the Meadview North Quadrangle, Mohave County, Arizona and Clark County, Nevada*: Nevada Bureau of Mines and Geology Map 154, scale 1:24,000, 1 sheet.
- Wenrich, K.J., Billingsley, G.H., and Huntoon, P.W., 1996, *Breccia-Pipe and Geologic Map of the Northeastern Part of the Hualapai Indian Reservation and Vicinity, Arizona*: U.S. Geological Survey Map I-2522, Miscellaneous Investigations Series, scale 1:48,000, 1 sheet.
- Wenrich, K.J., Billingsley, G.H., and Huntoon, P.W., 1997, *Breccia-Pipe and Geologic Map of the Northwestern Part of the Hualapai Indian Reservation and Vicinity, Arizona*: U.S. Geological Survey Map I-2440, Miscellaneous Investigations Series, scale 1:48,000, 1 sheet.
- Wernicke, B., and Axen, G.J., 1988, On the role of isostasy in the evolution of normal fault systems: *Geology*, v. 16, p. 848–851, doi: 10.1130/0091-7613(1988)016<0848:OTROI>2.3.CO;2.
- Whistler, D.P., and Lander, E.B., 2003, New late Uintan to early Hemingfordian land mammal assemblages from the undifferentiated Sespe and Vaqueros Formations, Orange County, and from the Sespe and equivalent marine formations in Los Angeles, Santa Barbara, and Ventura Counties, Southern California: *Bulletin of the American Museum of Natural History*, v. 279, p. 231–268, doi: 10.1206/0003-0090(2003)279<0231:C>2.0.CO;2.
- Woodford, A.O., Welday, E.E., and Merriam, R., 1968, Siliceous tuff clasts in Upper Paleogene of southern California: *Geological Society of America Bulletin*, v. 79, p. 1461–1486, doi: 10.1130/0016-7606(1968)79[1461:STCITU]2.0.CO;2.
- Young, R.A., 1966, Cenozoic Geology along the Edge of the Colorado Plateau in Northwestern Arizona [Ph.D. thesis]: St. Louis, Washington University, 167 p.
- Young, R.A., 1979, Laramide deformation, erosion and plutonism along the southwestern margin of the Colorado Plateau: *Tectonophysics*, v. 61, p. 25–47, doi: 10.1016/0040-1951(79)90290-7.
- Young, R.A., 1982, Paleogeomorphologic evidence for the structural history of the Colorado Plateau margin in western Arizona, *in* Frost, E.G., and Martin, D.L., eds., *Mesozoic-Cenozoic Tectonic Evolution of the Colorado River Region, California, Arizona and Nevada (Anderson-Hamilton Volume)*: San Diego, California, Cordilleran Publishers, p. 29–39.
- Young, R.A., 1985, Geomorphic evolution of the Colorado Plateau margin in west-central Arizona: A tectonic model to distinguish between the causes of rapid symmetrical scarp retreat and scarp dissection, *in* Hack, J.T., and Morisawa, M., eds., *Tectonic Geomorphology*: London, Allen and Unwin, p. 261–278.
- Young, R.A., 1999, Appendix: Nomenclature and ages of Late Cretaceous(?)–Tertiary strata in the Hualapai Plateau region, northwest Arizona, *in* Billingsley, G.H., Wenrich, K.J., Huntoon, P.W., and Young, R.A., eds., *Breccia-Pipe and Geologic Map of the Southwestern Part of the Hualapai Indian Reservation and Vicinity, Arizona*: U.S. Geological Survey Map I-2554, Miscellaneous Investigations Series, p. 21–50, scale 1:48,000.
- Young, R.A., 2001a, Geomorphic, structural and stratigraphic evidence for Laramide uplift of the southwestern Colorado Plateau margin in northwest Arizona, *in* Erskine, M.C., Faulds, J.E., Bartley, J.M., and Rowley, P.D., eds., *The Geologic Transition, High Plateaus to Great Basin: A Symposium and Field Guide: The Mackin Volume: Salt Lake City, Utah Geological Association*, p. 227–237.
- Young, R.A., 2001b, The Laramide–Paleogene history of the western Grand Canyon region: Setting the stage, *in* Young, R.A., and Spamer, E.E., eds., *Colorado River Origin and Evolution: Grand Canyon, Arizona*, Grand Canyon Association, p. 7–16.
- Young, R.A., 2008, Pre–Colorado River drainage in western Grand Canyon: Potential influence on Miocene stratigraphy in Grand Wash Trough, *in* Reheis, M.C., Hershler, R., and Miller, D.M., eds., *Late Cenozoic Drainage History of the Southwestern Great Basin and Lower Colorado River Basin: Geologic and Biotic Perspectives: Geological Society of America Special Paper 439*, p. 319–333.
- Young, R.A., and McKee, E.H., 1978, Early and Middle Cenozoic drainage and erosion in west-central Arizona: *Geological Society of America Bulletin*, v. 89, p. 1745–1750, doi: 10.1130/0016-7606(1978)89<1745:EAMCDA>2.0.CO;2.
- Young, R.A., and Spamer, E.E., 2001, *Colorado River Origin and Evolution: Grand Canyon, Arizona*, Grand Canyon Association, 280 p.
- Zachos, J., Pagani, M., Sloan, L., Thomas, E., and Billups, K., 2001, Trends, rhythms, and aberrations in global climate 65 Ma to present: *Science*, v. 292, p. 686–693, doi: 10.1126/science.1059412.
- Zeilinger, G., and Schlunegger, F., 2007, Possible flexural accommodation on the eastern edge of the Altiplano in relation to focused erosion in the Rio La Paz drainage system: *Terra Nova*, v. 19, p. 373–380, doi: 10.1111/j.1365-3121.2007.00762.x.

MANUSCRIPT RECEIVED 16 FEBRUARY 2010
 REVISED MANUSCRIPT RECEIVED 6 MAY 2010
 MANUSCRIPT ACCEPTED 28 JUNE 2010

Printed in the USA